



# **Determining the Composition and Collectibility of Child Support Arrearages**

## **Volume I: The Longitudinal Analysis**

May 2003

First Part of Final Report for Section 1115 Grant # 90-FD-0027  
Submitted to the Office of Child Support Enforcement  
Administration for Children and Families  
U.S. Department of Health and Human Services  
Washington, D.C.

*Carl Formoso, Ph.D.  
Management and Audit Program Statistics Unit  
Division of Child Support  
Economic Services Administration  
Washington State Department of Social and Health Services  
P.O. Box 9162  
Olympia, WA 98507*



# Determining the Composition and Collectibility of Child Support Arrearages

## Volume 1: Longitudinal Analysis

### Table of Contents

#### List of Tables and Figures

#### Executive Summary

#### Chapter Summaries

#### Chapter 1: Introduction

#### Chapter 2: Spells of Arrearage Debt Trends

page

- 2 ..... Spells Analysis
- 7 ..... Distribution of Spell Lengths and Costs

#### Chapter 3: Earnings, Order Amount, Payment Barriers, and Arrearage

page

- 2 ..... Relations between MOA, Earnings, and Arrearage Change
- 13 ..... Barriers to Payment
- 16 ..... Sample Frames for Case Assessment
- 18 ..... Incorporating Spells Analysis
- 25 ..... MOA Threshold
- 26 ..... Debt Collectibility

#### Chapter 4: Neural Network Prediction Model

page

- 3 ..... Model Definition
- 4 ..... MTW Not Useful in Prediction
- 5 ..... Predictive Results
- 10 ..... Applying the Predictive Model
- 11 ..... Incorporating Inputs from Cross-Program Use and Case-Level Analysis

## **Chapter 5: Decision Tree Prediction Model**

page

- 1 ..... Decision Tree Framework

## **Chapter 6: Effects of Prediction Input Variables**

page

- 1 ..... Effects of the Spell Duration Variables
- 5 ..... Effects of Indicator Variables
- 6 ..... The Effects of “Elig”
- 7 ..... The Effects of Continuous Variables

## **Chapter 7: Arrearage and Custodial Parent Work and Welfare Outcomes**

page

- 2 ..... Arrearage and Cost Avoidance

## **Chapter 8: Conclusions and Strategies**

### **Appendix A1: Data Sources and Methods**

page

- 1 ..... Longitudinal Analysis
- 3 ..... Sampling for Case Assessment

### **Appendix A2: Introduction to Neural Network Models**

### **Appendix A3: Development of Neural Network Predictive Model**

page

- 1 ..... Selecting Input Variables
- 3 ..... Selecting Network Architecture
- 6 ..... Selection of More Reliable Predictions
- 8 ..... Optimum Definition of Outcomes
- 9 ..... Optimum Network Training

### **Appendix A4: Development of Decision Tree Model**

page

- 1 ..... Complexity of Decision Points and Decision Trees
- 2 ..... Quality of Decision Points

## List of Tables and Figures

### Chapter 2

page

2	.....	Table 2.1: Distribution of Number of Spells
3	.....	Table 2.2: Summary of Spells & Costs
3	.....	Table 2.3: Overview of Spell Patterns
4	.....	Table 2.4: Additional Details of Spell Patterns
5	.....	Table 2.5: Spell Patterns with Inc. and/or Dec. Spells
5	.....	Figure 2.1: Distribution of NCPs over Number of Dec. Spells vs. Number of Inc. Spells
6	.....	Table 2.6: Summary of Spell Sequence
8	.....	Figure 2.2: Contour Diagram of Spell Frequency Distribution by Spell Length and Spell Cost

### Chapter 3

page

3	.....	Figure 3.1: Average Arrearage Change Related to Earnings and MOA
4	.....	Figure 3.2: Arrearage Change by MOA at \$0 Earnings
5	.....	Figure 3.3: Marginal Arrearage Cost for MOA Related to Earnings
6	.....	Figure 3.4: Marginal Payments Benefit for MOA Related to Earnings
7	.....	Figure 3.5: Contour View of Figure 3.1
7	.....	Figure 3.6: Creating a Zero Contour Representation
8	.....	Figure 3.7: Average Actual MOA Related to Earnings and Zero Contour Estimate
9	.....	Figure 3.8: Creating a Representation of Actual MOA
10	.....	Figure 3.9: Comparison of Actual MOA Estimate with Zero Contour Estimate
11	.....	Table 3.1: Characteristics of Four Wage Regions
12	.....	Figure 3.10: MTW Ratio Related to Earnings
13	.....	Figure 3.11: Arrearage Change Related to MTW Ratio
14	.....	Table 3.2: Barriers to Payment of Child Support
14	.....	Figure 3.12: Number of Barriers per NCP Related to Earnings
15	.....	Figure 3.13: MTW Ratio Related to Payment Barriers
16	.....	Figure 3.14: Arrearage Change Related to MTW and Barriers
17	.....	Figure 3.15: Location of Sampling Frames & Cohort Averages Relative to AME and ZCE
18	.....	Figure 3.16: Approximate Number of Missed Payments Related to Number of Increasing Spells and Number of Decreasing Spells
19	.....	Figure 3.17: MTW Related to Number of Increasing Spells and Number of Decreasing Spells
21	.....	Figure 3.18: MTW and ATM Follow the Same Pattern for NCPs with Only Increasing and Decreasing Spell Sequences Which Begin with an Increasing Spell

22	.....	Figure 3.19: MTW and ATM Follow the Same Pattern for NCPs with Only Increasing and Decreasing Spell Sequences Which Begin with a Decreasing Spell
23	.....	Figure 3.20: Percentage of Spell Types Related to Earnings
24	.....	Figure 3.21: Duration of Spells Related to Earnings
25	.....	Figure 3.22: Cost of Spells Related to Earnings
28	.....	Table 3.3.a: Groupings for Lowest Wage Category
29	.....	Table 3.3.b: Groupings for Mid Wage Category
30	.....	Table 3.3.c: Groupings for High Wage Category

## **Chapter 4**

page

4	.....	Table 4.1: Predictive Models Base Period Input Variables
4	.....	Table 4.2: Predictive Models Output Variables
5	.....	Figure 4.1: Comparing MTW for Spell Sequences Ending with an Increase or with a Decrease, for NCPs with Only Increasing and Decreasing Spells
6	.....	Table 4.3: Testing the Optimized Models
8	.....	Table 4.4: Selected Testing of the Optimized Models
9	.....	Table 4.5: Prediction Results and Base Period durM
9	.....	Figure 4.2: Prediction Quality Depends on High durM
11	.....	Table 4.6: Applying the Optimized Models
12	.....	Table 4.7: Cross-Program Input Variables
13	.....	Table 4.8: Including Cross-Program Inputs

## **Chapter 5**

page

2	.....	Figure 5.1: Basic Decision Tree Framework
3	.....	Table 5.1: Decision Tree Rules and Results for Q3 Predictions

## **Chapter 6**

page

2	.....	Figure 6.1: Effects of “durZ” on 95Q3 Outcomes
3	.....	Figure 6.2: Effects of “durN” on 95Q3 Outcomes
3	.....	Figure 6.3: Effects of “durP” on Outcomes
4	.....	Figure 6.4: Variability of “durN” Effects on Q3 Outcomes
5	.....	Figure 6.5: Effects of Indicator Variables on Q3 Outcomes
6	.....	Figure 6.6: Effects of “Elig” on Outcomes
7	.....	Figure 6.7: Effects of “T95Q3” on Outcomes
8	.....	Figure 6.8: Effects of “Earn” on Outcomes

## Chapter 7

page

- 2 ..... Table 7.1: Characteristics of NCPs Aggregated by CP Classification
- 3 ..... Table 7.2: CP Classification Aggregated by NCP MTW Level
- 3 ..... Figure 7.1: CP Outcomes Aggregated by NCP MTW Level

## Appendix A1

page

- 2 ..... Table A1.1: DCS Variables with No Predictive Power
- 3 ..... Table A1.2: Variables Eliminated in Model Development
- 4 ..... Figure A1.1: Spell Length-Spell Cost Location of Case-Level Random Samples
- 5 ..... Table A1.3: Characteristics of Sampled Populations and Random Samples

## Appendix A2

page

- 1 ..... Figure A2.1: Simulated Complex Data Demonstrating Neural Network Capabilities
- 2 ..... Figure A2.2: Network Architecture: Two Networks Used on Simulated Data
- 3 ..... Figure A2.3: Simplified Network Notation
- 4 ..... Figure A2.4: Neural Network Transfer Functions

## Appendix A3

page

- 2 ..... Figure A3.1: Preliminary Neural Network for Testing Inputs
- 3 ..... Table A3.1: Case Variables with Possible Predictive Power
- 4 ..... Figure A3.2: Three Neural Network Prediction Models
- 5 ..... Table A3.2: Testing the Models Shown in Figure A3.2
- 7 ..... Figure A3.3: Accuracy of Prediction is Related to Z Score
- 8 ..... Table A3.3: Predictions with Increasing Z Score Cut-Off

## Appendix A4

page

- 2 ..... Figure A4.1: Example of Decision Point Quality



# **Determining the Composition and Collectibility of Child Support Arrearages**

## **Volume 1: Longitudinal Analysis**

### **Executive Summary**

It is well known that past due child support - arrearage - is a problem nationally and in most states. This study was undertaken to help in understanding the nature of child support debt, the factors which lead to debt growth, the factors which lead to a controlled or shrinking debt, and to suggest strategies and approaches for mitigation of debt growth.

The most important finding presented here, in terms of policy considerations, is the identification of the level of child support obligation which on average prevents arrearage growth, related to noncustodial parent earnings. Concomitant with this is the finding that for noncustodial parents with gross monthly earnings below about \$1,400, child support obligation is on average set far above the level that would prevent arrearage growth. In addition low income noncustodial parents have a heavier relative burden of obligation - as earnings decrease support obligation as a percentage of income rises steeply. This finding is also corroborated by other studies outside of Washington State. Yet it appears that obligations have generally been set in accordance with existing regulations, policies, and practices. This suggests a serious need for review of policies which result in setting child support obligations for low income noncustodial parents.

The longitudinal analysis also found that when noncustodial parent gross monthly earnings were above about \$1,400 child support obligation is on average set below the level which prevents arrearage growth, and that in the earnings span from \$3,000 to \$6,000 a higher obligation leads to nearly complete additional collections. This was not investigated in this study because it is not an arrearage problem, but it may imply that how child support obligations are set across the entire earnings spectrum is in need of reconsideration.

There are several indications from this study that when child support obligations are set above about 20 percent of gross earnings arrearage growth will, on average, occur. Even low income noncustodial parents will tend not to accumulate arrearage debt if the support obligation is 20 percent of earnings, or lower. However, almost half of the noncustodial parents with reported earnings in this study have a support obligation greater than 20 percent of gross earnings.

The longitudinal analysis examines the composition of arrearages by viewing dynamic patterns of arrearage debt change. While overall arrearages are contin-



uously increasing, only about one out of twenty noncustodial parents show continuously increasing arrears during the 15 quarters of this study. The dynamic patterns are complex, but a common behavior is alternating cycles of increasing arrears and decreasing arrears. A spell of increasing arrearage has a 64 percent probability of being followed by a spell of decreasing arrears, while a spell of decreasing arrears has a 47 percent probability of being followed by a spell of increasing arrears. However the cost of increasing spells far outweighs the income from decreasing spells. And when support obligation is above 20 percent of earnings the increasing spells begin to outnumber the spells of decreasing arrears. The dynamic composition of arrearage debt varies with earnings, with long spells of increasing debt predominating at lowest earnings, and long spells with no change in debt predominating at highest earnings.

The longitudinal analysis also links the burden of child support obligation to work and welfare outcomes for the custodial family. Previous work in Washington State has shown that when custodial parents receive regular payments of child support their rate of welfare re-entry is lower, and, while they are off welfare, their rate of employment is higher. Findings in this report show that when the burden of child support obligation is 20 percent or less of noncustodial parent earnings, the associated custodial parent is more than three times more likely to be classified with regular payments. The 20 percent threshold not only appears to control the growth of arrearage debt, but also makes favorable outcomes for the custodial family more likely. In turn a support obligation set too high relative to earnings on average appears to lead to arrearage growth, little or no income to the state and federal government in terms of reimbursement for public assistance, and little or no benefit for the custodial family.

This report develops two potentially useful tools for managing child support arrearage debt. It is shown that child support arrearage debt can be classified as either mostly collectible or mostly uncollectible. Different strategies are suggested for working with noncustodial parents in different categories of debt collectibility. The second tool developed allows a fairly accurate prediction of the direction of change in arrearage debt on an individual noncustodial parent basis. The combination of good predictability with classification of debt collectibility can point the way to new approaches for the management of child support arrearage debt.

# Determining the Composition and Collectibility of Child Support Arrearages

## Volume 1: Longitudinal Analysis

### ~ Chapter Summaries ~

#### Chapter 1: Introduction

*No summary - see main text*

#### Chapter 2: Spells of Arrearage Debt Trends

*The composition of arrearage is examined in terms of the dynamics of arrearage change over the fifteen quarters of this study. Patterns of arrearage behavior are very complex. Only 5.8 percent of noncustodial parents had continually increasing arrearage through the period, and only 1.3 percent had continually decreasing arrears. But 55.3 percent had four or more separate spells of arrearage behavior including increasing and/or decreasing arrearage. On average a particular arrearage behavior lasted only 3.3 quarters. The most common pattern is alternating spells of increasing arrears and decreasing arrears. Sixty-four percent of all spells of increasing debt were terminated by a debt decrease. Forty-seven percent of all spells of decreasing debt were terminated by a debt increase. Overall the number of spells of increasing arrearage is only slightly greater than the number of spells of decreasing arrearage. However, the total cost of spells of increasing arrearage, \$1.134 billion, was only partially balanced by the total cost reduction of spells of decreasing arrearage, -\$592 million, for a total arrearage increase of \$543 million over the fifteen quarters.*

### **Chapter 3: Earnings, Order Amount, Payment Barriers, and Arrearage**

*Important underlying patterns in arrearage behavior have been discovered by examining arrearage change in relation to monthly earnings and monthly ordered child support obligations. With this information we are able to identify for monthly gross wages from \$0 to \$6,000 the level of support obligations where arrearage did not grow. However, below about \$1,400 wages support obligations have on average been set far above the level that would prevent arrearage growth. Above \$1,400 wages support obligations have on average been set far below the level where arrearage would grow, leading to a generally decreasing arrearage debt or a debt that does not build up. Noncustodial parents with low earnings are responsible for the bulk of debt growth, but on average they are expected to pay a large fraction, sometimes all, of their income towards child support. The parents with low earnings also have, on average, a disproportionately larger share of barriers to payment.*

*These factors are then related to the spells analysis record from Chapter 2, and provide some understanding of the cycle of spells of increasing arrears alternating with spells of decreasing arrears. The dynamic patterns composing arrearage change vary continuously as earnings increase. At the lowest earnings spells of increasing debt predominate in frequency, duration, and cost. At the highest earnings long spells with no arrearage change are common, with infrequent interspersed short spells of decreasing arrearage and very short spells with increasing debt.*

*This chapter ends with a demonstration that the principles developed can be used to classify the collectibility of debt. Preliminary classification for in-state noncustodial parents shows \$273 million as debt growth that could have been mostly/partially collectible, and \$374 million as debt growth that was mostly not collectible.*

## **Chapter 4: Neural Network Prediction Model**

*While, as shown in Chapter 2, the patterns of arrearage change are very complex, good predictions of arrearage change outcomes are possible. The neural network prediction model for child support arrearage debt is able to predict, with up to about 80 percent accuracy, the direction of change in arrearage debt for individual noncustodial parents (NCPs). The model requires NCP information from an eight quarter base period, and can make predictions for three quarters in the future or seven quarters in the future. The model shows a 127 percent increase in the number of correct predictions seven quarters in the future compared to more standard approaches.*

*The prediction system does not attempt to make predictions for all NCPs submitted, but is able to select those NCPs for whom outcomes can be more reliably predicted. It appears that for a general group of NCPs third quarter predictions will be made for about 60 percent of the individuals and up to about 75 percent of the predictions will be correct; seventh quarter predictions will be made for about 50 percent of the individuals and up to about 70 percent of the predictions will be correct. Better predictions can be made by pre-selecting individuals based on their history. For example, pre-selecting individuals with the highest earnings allowed third quarter predictions to be made for 80 percent of the individuals and 83 percent of the predictions were correct. Applications of the prediction system to newly defined NCP cohorts show promising results.*

## **Chapter 5: Decision Tree Prediction Model**

*The decision tree model is a second, and much simpler, approach to using predictability. From a general group of noncustodial parents (NCPs) the decision tree model is able to select a 10 percent sub-group of individuals who have about an 80 percent probability of increased arrearage three quarters in the future, and a different 10 percent sub-group who have about an 8 percent probability of increased arrearage three quarters in the future.*

## **Chapter 6: Effects of Prediction Input Variables**

*We view overall averages to gain some understanding of the effects of each prediction input variable on arrearage change outcomes. But this, at best, only applies to large groups of individuals. With small groups of individuals the effects of a particular input variable may depend on several other input variables. This does, however, give us a general view of the effects of several important measures related to arrearage.*

## **Chapter 7: Arrearage and Custodial Parent Work and Welfare Outcomes**

*Past work has shown that custodial parents who receive regular child support payments have more favorable work and welfare outcomes. In this chapter the arrearage characteristics of the noncustodial parent are linked to subsequent custodial parent welfare use and custodial parent employment.*

*For custodial parents classified with regular child support payments the associated noncustodial parent is expected to pay a significantly lower percentage of monthly income, providing some explanation for regularity of payment. Additionally, noncustodial parents whose child support obligations are 20 percent or less of monthly earnings are over three times more likely to be associated with custodial parents classified with regular payments.*

## **Chapter 8: Conclusions and Strategies**

*No summary - see main text*

## **Chapter 1: Introduction**

This document presents the first part of a two volume report on the methods and the findings of a study of child support arrearages in Washington State.

When we began this study in mid-1999 child support debt was very large and growing, both in Washington State and nationally. At the mid-point of the study reported here, the third calendar quarter of 1995, 72 percent of Washington State noncustodial parents owed arrears, yet only 33 percent of these debtors paid down arrearage in the following quarter. Attention has become more focused on debt with legislative and policy changes implemented since 1997, yet arrearages have continued to grow, perhaps at an even faster rate after Federal Fiscal Year 1998 (see Sorensen, et al., 2003; Figure 1 in Executive Summary).

Until the passage of PRWORA and the accompanying federal legislation, holding child support debt could benefit states through the possibility of collections at some later time. This may have created incentives for extending the statute of limitations, charging interest or fees, and not exploring the provisions for writing off bad debt used by private businesses. Past policies did not discourage, and may have encouraged, the accrual of large child support debts.

Welfare reform and subsequent child support legislation radically changed how arrearage debt impacts child support agencies. One of the new federal performance indicators, upon which child support agencies' incentive funding is computed, measures the percentage of cases paying toward arrears. Many state child support agencies, including the Washington State Division of Child Support (DCS), show poor results on this measure. The new incentive system gives states reasons to be much more concerned about the size of arrearages and to understand and begin to mitigate the factors which lead to their accumulation.

Welfare reform also changed the distribution of dollars collected on child support arrears. Under the previous system any child support collected for a family on AFDC was assigned to the state and the federal government, which then kept money collected to reimburse the costs of public assistance. After leaving AFDC the custodial family could receive support collected, but arrearage debt remained subrogated to the government. In many of Washington's child support cases collections never fully reimburse public assistance expended on the family.

Under the current system, arrears due the custodial parent before and after the period on public assistance will go back to the custodian. In October 1997, DCS began tracking "temporarily assigned arrears" separately from arrears accumulated while the family was on assistance. In October 2000 DCS began to return temporarily assigned arrears to the family. Presently, further federal changes are under discussion. But whatever the outcome, the prospect is for

families to get more of the support dollars collected, dollars that previously would have remained assigned to the state and federal government.

While this is good for the family, it does create new concerns for the agency. The state not only loses some reimbursement but also loses its discretion to forgive some debt. Washington law gives the Department of Social and Health Services (the parent agency of DCS) authority under specified circumstances to forgive debts owed to the department. DCS conference boards can and do write off part or all of a subrogated debt for hardship reasons. Subrogated debts can also be used as negotiation tools.

Consequently, at the same time that DCS gained a new incentive to control the growth of arrearage debt, it also lost flexibility to manage debt through administrative actions.

In 1999 Washington State, along with Colorado and Virginia, were awarded Federal Section 1115 Grants under announcement DCL 99-42 to undertake studies to enable more understanding of the composition and collectibility of debt and to develop strategies to mitigate debt growth. There have also been other recent related studies undertaken in California (Sorensen, et al., 2003) and nationally (OIG, 2002).

Our approach in Washington State has been to look both wide and deep. This includes intensive analyses of administrative and case data, as well as a review of state statutes and agency programs, policies, and initiatives. Our goals were to understand the processes and components of child support that lead to large debts, to understand why some debts do not grow, to document the mitigating effects of interventions on collectibility, to determine the impact of law and policies on debt growth, and to recommend changes that can lead to lower arrearages.

The analytical studies began with the identification of a large cohort of noncustodial parents - all who were identifiable in Washington State records in the third quarter of calendar year 1995. The wide study - which we are calling the longitudinal analysis - is based on individuals and uses administrative records from a number of sources to investigate characteristics, behavior, and outcomes over a fifteen quarter period. The deep study - which we are calling the case assessment - intensively examines case details for four samples from the main cohort for the entire case history up to March 2001. This two-tiered analysis of child support arrearage was designed to quantify the rate of arrearage growth, reliably predict debt growth outcomes and collectibility, and explain why the patterns occur. We wanted to document not only what is happening, but also why it is happening.

This report, Volume 1, presents the longitudinal analysis. Volume 2, reporting on the case assessment study (Peters, 2003), will be issued separately.

The first part of the longitudinal study focuses on changes which occurred during the fifteen quarters of observation, looking first (Chapter 2) at the dynamic quarter-to-quarter patterns of change in arrearage debt. Then by relating the fifteen quarter overall debt change to earnings and child support obligation (Chapter 3) we are able to identify over a range of earnings the level of obligation where, on average, arrearage did not grow. However, below a threshold earning level child support obligation has on average been set far above the level that would prevent arrearage growth, and noncustodial parents are expected to pay a very large percentage of earnings as child support. Thus Chapter 3 begins to examine possible reasons for debt increase or decrease, and also some of the reasons for the dynamic patterns of increase or decrease. The information in Chapter 3 allows us to begin developing a strategy for classifying debt as collectible or uncollectible, as well as strategies for managing debt in different groups of noncustodial parents.

The second part of the longitudinal analysis is a documentation of predictability in arrearage debt change (Chapters 4 and 5). In this part we use information from the first eight quarters to develop models predicting outcomes in the final seven quarters. These models perform very well, and the more powerful model (Chapter 4) maintains good predictive power even when applied to an entirely new group of noncustodial parents set in a time frame with very different economic conditions.

Finally, in Chapter 7, the longitudinal analysis links noncustodial parent child support obligation as a percentage of earnings to regularity of payment for the custodial parent, and thus to outcomes for the custodial family.

Chapter 8 draws together the different aspects of the longitudinal analysis.

The case assessment study, to be reported in Volume 2 (Peters, 2003), analyzes the impact of field work. It is based upon samples representing four debt patterns identified by the longitudinal analysis. Its focus is an intensive review of the cases to capture information from case comments and integrate it with other data drawn from extracts. In contrast to the longitudinal analysis, the case assessment is not limited to the 15 quarter period. The case assessment examines issues at both the case level and the individual level, and is retrospective rather than predictive. The case assessment examines the composition of arrearages in terms of the source of debt.



## **Chapter 1 References**

- 1) Peters, 2003: Jo Peters, "Determining the Composition and Collectibility of Child Support Arrearages, Volume 2: The Case Assessment," in preparation.
- 2) Sorensen, et al., 2003: Elaine Sorensen, Heather Koball, Kate Pomper, and Chava Zibman; "Assessing the Collectibility of Child Support Arrears in California," prepared for the Department of Child Support Services, California, December 2002.
- 3) OIG, 2002: DHHS Office of Inspector General; "Child Support for Children on TANF," OEI-05-99-00392, February, 2002.

## Chapter 2: Spells of Arrearage Debt Trends

### Summary

*The composition of arrearage is examined in terms of the dynamics of arrearage change over the fifteen quarters of this study. Patterns of arrearage behavior are very complex. Only 5.8 percent of noncustodial parents had continually increasing arrearage through the period, and only 1.3 percent had continually decreasing arrears. But 55.3 percent had four or more separate spells of arrearage behavior including increasing and/or decreasing arrearage. On average a particular arrearage behavior lasted only 3.3 quarters. The most common pattern is alternating spells of increasing arrears and decreasing arrears. Sixty-four percent of all spells of increasing debt were terminated by a debt decrease. Forty-seven percent of all spells of decreasing debt were terminated by a debt increase. Overall the number of spells of increasing arrearage is only slightly greater than the number of spells of decreasing arrearage. However, the total cost of spells of increasing arrearage, \$1.134 billion, was only partially balanced by the total cost reduction of spells of decreasing arrearage, -\$592 million, for a total arrearage increase of \$543 million over the fifteen quarters.*

The longitudinal study uses a cohort of 241,731 noncustodial parents (NCPs) - all who were identifiable in Washington State records in the third quarter of calendar year 1995 (95Q3). Fifteen quarters of data was acquired for these individuals - from the fourth calendar quarter of 1993 (93Q4) to the second calendar quarter of 1997 (97Q2). For the study reported in this chapter child support arrearage data was converted into a series of succeeding quarters, or spells, of debt trend and associated cost for each spell. The spell structure is created by looking at quarter-to-quarter differences in arrearage levels and determining the length of time during which arrears continually increased (*Inc. spells*), continually decreased (*Dec. spells*), showed no change (*NoCh. spells*), or where changes were not determinable due to quarters with no data for the noncustodial parent (*UnDt. spells*).

## Spells Analysis

There are 241,731 individual noncustodial parents in this cohort with, on average, 4.2 separate trend spells for each individual, and 1,018,863 separate spells for the entire group. Most individuals have more than one spell - only 28,255, or 11.7 percent, have only one spell of debt trend. While spell durations ranged from 1 to 14 quarters, the average spell length was only 3.3 quarters. Table 2.1 shows the distribution of NCPs over the number of spells.

**Table 2.1: Distribution of Number of Spells**

Number of		% of
Spells	NCPs	NCPs
1	28,255	11.7%
2	33,381	13.8%
3	45,714	18.9%
4	36,679	15.2%
5	32,452	13.4%
6	24,595	10.2%
7	17,371	7.2%
8	11,113	4.6%
9	6,165	2.6%
10	3,416	1.4%
11	1,549	0.6%
12	671	0.3%
13	259	0.1%
14	111	0.0%

Spells with increasing debt were only slightly more numerous than spells with decreasing debt (345,483 vs. 321,137), but were more cost intensive (\$3,283 per spell vs. -\$1,842 per spell) and involved more noncustodial parents (189,389 vs. 169,329). Table 2.2 gives details and also shows that while the total arrearage debt increased by \$543 million, this is comprised of a debt increase of \$1.134 billion caused by *Inc. spells*, and a debt decrease of \$592 million caused by *Dec. spells*.

**Table 2.2: Summary of Spells & Costs**

Spell Type	# Spells	Avg Cost	Avg		Cost/Indiv	Tot Cost
			Time, Q	# Indiv		Millions
<b>All Dec.</b>	321,137	-\$1,842	2.4	169,329	-\$3,494	-\$592
<b>All NoCh.</b>	233,265	\$0	4.1	160,133	\$0	\$0
<b>All Inc.</b>	345,483	\$3,283	3.4	189,389	\$5,990	\$1,134
<b>All UnDt.</b>	118,978	assumed \$0	4.0	97,719	\$0	\$0
<b>All spells</b>	1,018,863	\$533	3.3	241,731	\$2,245	\$543

We also consider the patterns of spell sequence. For the entire time period and the entire cohort there are 6,458 unique patterns. Table 2.3 gives a general idea of the composition of these patterns in terms of the number of spell types involved. Table 2.4 shows more detail by including the spell types involved.

**Table 2.3: Overview of Spell Patterns**

Spell Types	Number of NCPs	% of NCPs	Avg # of Spells/NCP
<b>One</b>	28,255	11.7%	1.0
<b>Two</b>	88,923	36.8%	3.5
<b>Three</b>	87,743	36.3%	5.2
<b>Four</b>	36,810	15.2%	6.0

**Table 2.4: Additional Details of Spell Patterns**

Number of Spell Types	Selected Pattern	Number of		% of NCPs	Tot # of Spells	Avg # of Spells/NCP
		Patterns	NCPs			
<b>All</b>	<b>All</b>	6,458	241,731	100.0%	1,018,863	4.2
<b>One</b>	<b>Inc. (I)</b>	1	13,993	5.8%	13,993	1.0
	<b>Dec. (D)</b>	1	3,084	1.3%	3,084	1.0
	<b>NoCh. (N)</b>	1	11,015	4.6%	11,015	1.0
	<b>UnDt. (U)</b>	1	163	0.1%	163	1.0
<b>Two</b>	<b>I &amp; D</b>	26	42,282	17.5%	187,963	4.4
	<b>I &amp; N</b>	15	8,891	3.7%	22,043	2.5
	<b>I &amp; U</b>	9	6,690	2.8%	14,929	2.2
	<b>D &amp; N</b>	22	9,854	4.1%	33,422	3.4
	<b>D &amp; U</b>	8	1,346	0.6%	3,038	2.3
	<b>N &amp; U</b>	11	19,860	8.2%	49,575	2.5
<b>Three</b>	<b>I &amp; D &amp; N</b>	2,930	54,893	22.7%	322,020	5.9
	<b>I &amp; D &amp; U</b>	237	14,040	5.8%	67,238	4.8
	<b>I &amp; N &amp; U</b>	132	11,790	4.9%	42,041	3.6
	<b>D &amp; N &amp; U</b>	143	7,020	2.9%	28,783	4.1
<b>Four</b>	<b>I &amp; D &amp; N &amp; U</b>	2,921	36,810	15.2%	219,556	6.0

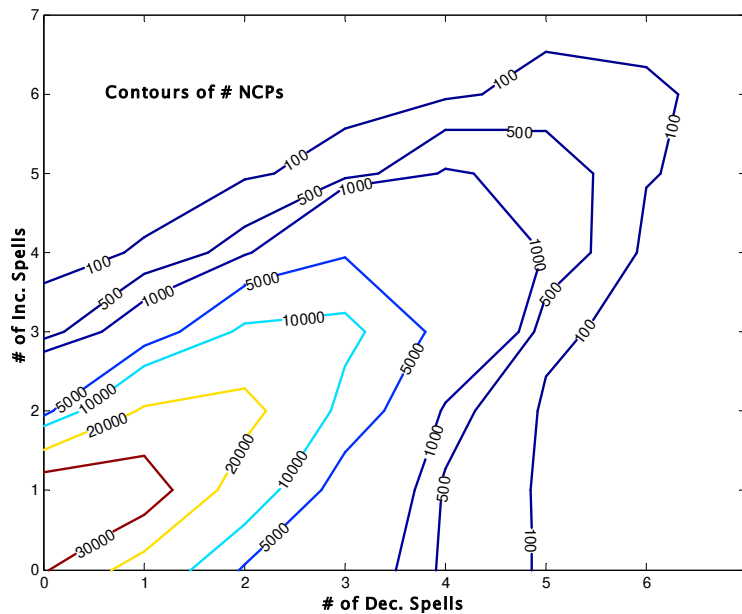
The patterns which affect arrearage debt are those which include *Inc. spells* and/or *Dec. spells*. Table 2.5 isolates those patterns from Table 2.4 and shows that nearly 70 percent of NCPs are involved in spell patterns which affect arrearage, that these patterns are the bulk - about 95 percent - of the 6,458 patterns seen in this study, and that about 80 percent of the total 1,018,863 spells in this study are part of patterns which include *Inc. spells* and/or *Dec. spells*.

**Table 2.5: Spell Patterns with Inc. and/or Dec. Spells**

Number of Spell Types	Selected Pattern	Number of		% of NCPs	Tot # of Spells	Avg # of Spells/NCP
		Patterns	NCPs			
One	Inc.	1	13,993	5.8%	13,993	1.0
	Dec.	1	3,084	1.3%	3,084	1.0
Two	I & D	26	42,282	17.5%	187,963	4.4
Three	I & D & N	2,930	54,893	22.7%	322,020	5.9
	I & D & U	237	14,040	5.8%	67,238	4.8
Four	I & D & N & U	2,921	36,810	15.2%	219,556	6.0
<b>Totals</b>		<b>6,116</b>	<b>165,102</b>	<b>68.3%</b>	<b>813,854</b>	<b>4.9</b>

Figure 2.1 shows that when both *Inc. spells* and *Dec. spells* are part of a pattern it is most common for the number of *Inc. spells* to be approximately equal to the number of *Dec. spells*. This agrees with Table 2.2 where we see that the total number of *Inc. spells* - 345,483 - is not very different from the total number of *Dec. spells* - 321,137. However Figure 2.1 tells additionally that it is very typical for the particular NCPs contributing a number of *Inc. spells* to also be contributing about the same number of *Dec. spells*.

**Figure 2.1: Distribution of NCPs over Number of Dec. Spells vs. Number of Inc. Spells**



Looking at spell patterns in a different way, Table 2.6 groups spells according to the event which ended the spell. The most common pattern was an *Inc. spell* followed by a *Dec. spell*. Sixty-four percent of all spells of increasing debt were terminated by a debt decrease. However, because spells of increasing debt terminated by a debt decrease are so common, this pattern makes the largest contribution, \$514 million, to debt increase. The most cost intensive spell pattern in Table 2.6 is an *Inc. spell* until the end of observation with an average spell cost of \$6,481. This must be considered a minimal value since it is unknown how long the spell continued or how much debt increased after observation ended. This pattern shows 78,285 NCPs, or 32 percent of the cohort, responsible for about 45 percent of the total increase of \$1.134 billion.

**Table 2.6: Summary of Spell Sequence\***

<b>Spell Type</b>	<b>End Event</b>	<b># of Spells</b>	<b>Avg cost</b>	<b># indiv</b>	<b>Tot Cost millions</b>
Inc.	Dec.	222,190	\$2,314	133,768	\$514
Dec.	Inc.	150,736	-\$1,454	93,625	-\$219
Dec.	NoCh.	98,750	-\$1,948	77,623	-\$192
NoCh.	Inc.	92,398	\$0	78,716	\$0
Inc.	end	78,285	\$6,481	78,285	\$507
Dec.	end	61,241	-\$2,395	61,241	-\$147
NoCh.	end	59,424	\$0	59,424	\$0
NoCh.	Dec.	49,614	\$0	38,457	\$0
UnDt.	end	42,781	\$0	42,781	\$0
UnDt.	NoCh.	40,702	\$0	39,943	\$0
Inc.	NoCh.	38,629	\$2,192	34,821	\$85
NoCh.	UnDt.	31,829	\$0	31,244	\$0
UnDt.	Inc.	27,881	\$0	27,535	\$0
Dec.	UnDt.	10,410	-\$3,210	10,331	-\$33
UnDt.	Dec.	7,614	\$0	7,569	\$0
Inc.	UnDt.	6,379	\$4,403	6,309	\$28

\* end in **End Event** column means end of observation, i.e the end event is unknown

If we also consider the event preceding the spell, the most expensive pattern is increasing arrearage for the entire observation period. In this case both the beginning and the end of the spell are unknown. There were 13,993 noncustodial parents who showed this pattern with an average spell cost of \$14,436 and a total contribution to increasing arrearage of \$202 million. This is 5.8 percent of the noncustodial parents responsible for 17.8 percent of the total increase of \$1.134 billion.

The second most common pattern in Table 2.6 is a spell of decreasing debt followed by a spell of increasing debt. About 47 percent of *Dec. spells* are followed by a *Inc. spell*, and these account for about 37 percent of the total debt decrease of \$592 million.

Considering both preceding and following events to *Dec. spells* there are only 3,084 NCPs with decreasing debt for the entire period. While the average debt decrease is \$6,501 per spell, because of the small number they do not have a large cost impact. The largest contribution to decreasing debt is from spells of decreasing debt both preceded and followed by spells of increasing debt.

### **Distribution of Spell Lengths and Costs**

By using spell lengths and categorizing spell costs for the entire set of 1,018,863 spells (see Table 2.2) we can obtain frequencies of occurrence of the various length-cost combinations. Except for the largest cost increases and decreases, costs are classified into \$1,000 intervals, with the class label being the lowest (most negative) value in thousands. Thus *Cost Class -5* includes spells with costs greater than or equal to - \$5,000, but less than - \$4,000 and *Cost Class 0* includes spells with costs greater than or equal to \$0, but less than \$1000. The lowest *Cost Class*, -12, includes spells with costs of less than - \$11,000 and the highest *Cost Class*, 11, includes spells with costs greater than or equal to \$11,000. This categorization provides 14 spell lengths and 24 cost classifications, or 336 cells of length-by-cost classification.

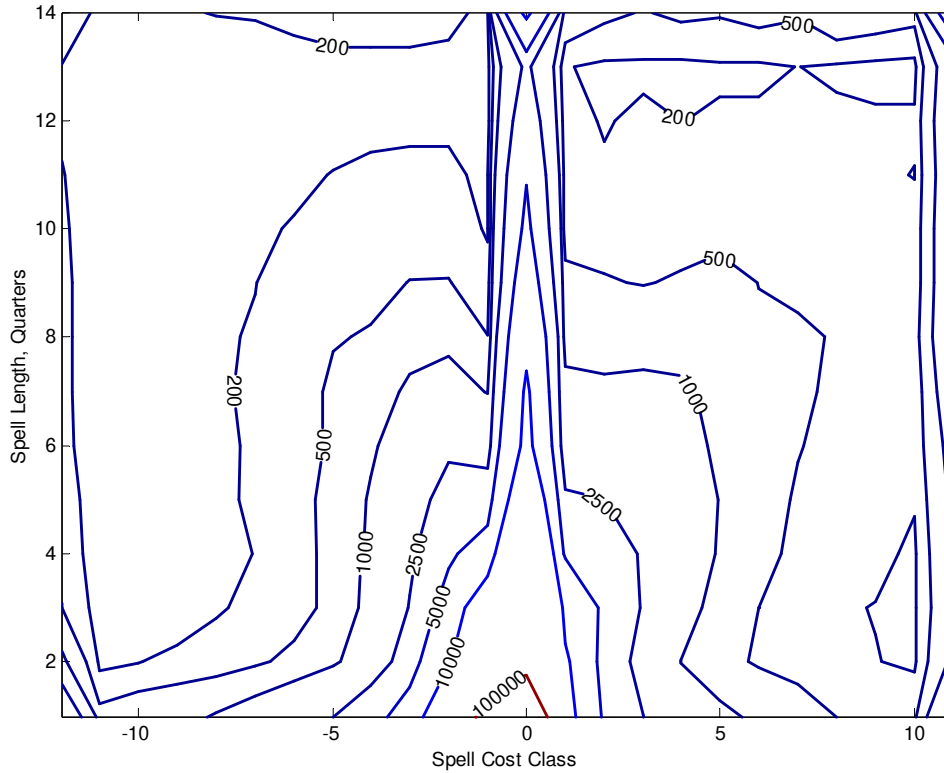
Figure 2.2 shows a 3-dimensional distribution of spell frequency as a contour diagram. The contour labels indicate the number of spells which were grouped into the particular length-by-cost cell. It can be seen that at any spell duration the most common (most frequently occurring) cost is in the 0 *Cost Class*. There seems to be a strong tendency for short duration, low cost spells because the peak of the distribution is in the 1 quarter length, 0 *Cost Class* cell with 207,256 spells. There is a secondary peak in the 14 quarters length, 0 *Cost Class* cell with 11,084 spells.

Note that Figure 2.2 is for spells, not individuals. Since individuals had an average of over 4 spells each, a particular NCP may be located in several of the cells of Figure 2.2.

Figure 2.2 was also the basis for setting up sampling frames for the case assessment analysis. Details of the sampling are discussed in Appendix A1 and additional details will be reported in Volume 2, the case assessment report (Peters, 2003).



**Figure 2.2: Contour Diagram of Spell Frequency Distribution by Spell Length and Spell Cost**



## Chapter 2 References

- 1) Peters, 2003: Jo Peters, "Determining the Composition and Collectibility of Child Support Arrearages, Volume 2: The Case Assessment," in preparation.

## Chapter 3: Earnings, Order Amount, Payment Barriers, and Arrearage

### Summary

*Important underlying patterns in arrearage behavior have been discovered by examining arrearage change in relation to monthly earnings and monthly ordered child support obligations. With this information we are able to identify for monthly gross wages from \$0 to \$6,000 the level of support obligations where arrearage did not grow. However, below about \$1,400 wages support obligations have on average been set far above the level that would prevent arrearage growth. Above \$1,400 wages support obligations have on average been set far below the level where arrearage would grow, leading to a generally decreasing arrearage debt or a debt that does not build up. Noncustodial parents with low earnings are responsible for the bulk of debt growth, but on average they are expected to pay a large fraction, sometimes all, of their income towards child support. The parents with low earnings also have, on average, a disproportionately larger share of barriers to payment.*

*These factors are then related to the spells analysis record from Chapter 2, and provide some understanding of the cycle of spells of increasing arrears alternating with spells of decreasing arrears. The dynamic patterns composing arrearage change vary continuously as earnings increase. At the lowest earnings spells of increasing debt predominate in frequency, duration, and cost. At the highest earnings long spells with no arrearage change are common, with infrequent interspersed short spells of decreasing arrearage and very short spells with increasing debt.*

*This chapter ends with a demonstration that the principles developed can be used to classify the collectibility of debt. Preliminary classification for in-state noncustodial parents shows \$273 million as debt growth that could have been mostly/partially collectible, and \$374 million as debt growth that was mostly not collectible.*

In this chapter we take an overall view of the period under study and examine how three particular factors relate to arrearage behavior. Findings from the case assessment (Peters, 2003) have suggested the importance of the ratio of Monthly Order Amount (MOA) to Monthly Wage - this is called MTW and reflects the burden of the monthly child support obligation. The median MTW was found to be 1.77 for NCPs in the '*Increasing*' debt pattern, but only 0.044 for NCPs in the '*Decreasing*' debt pattern. Clearly this is important because it is rather easy for someone to pay out about 4 percent of their monthly income and basically impossible for anyone to regularly pay out 1.8 times their gross monthly income.

We generalize this finding by using the entire 95Q3 cohort. Arrearage debt change over the 15 quarters was found by subtracting the last recorded debt from the first recorded debt. In this way we avoided the problem of missing data, except for 156 NCPs who were only in the data in 95Q3, the selection quarter. Thus this part of the study only involves the 241,575 NCPs who have a defined change in arrearage debt. For each NCP we also determined average monthly earnings and average MOA over the 15 quarters. Through DCS records for 95Q3 and through cross-program data (see discussion on cross-program data in Chapter 4) we also incorporate information on possible barriers to payment for each NCP. While there is considerable variability in this data, our approach in this Chapter is to suppress variability in order to see underlying patterns which might help us better understand the interaction between these factors and arrearage debt.

We also relate this work back to the spells analysis discussed in Chapter 2 and show that the interaction between wage and MOA allows us some understanding of the dynamic cycle between spells of increasing debt and spells of decreasing debt.

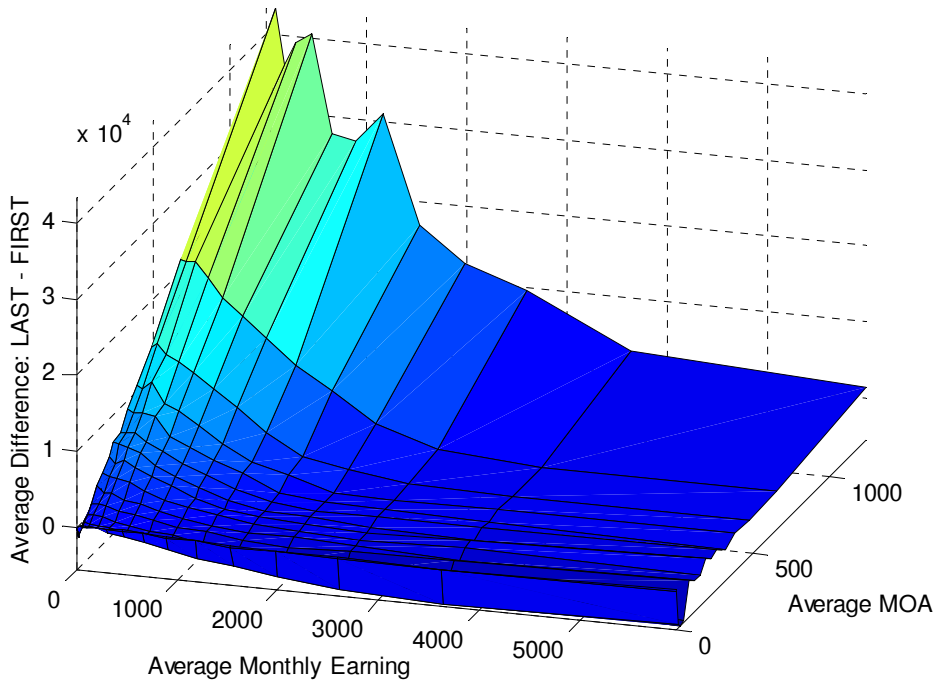
We then show how information on earnings, MOA, barriers and arrearage history can be used to approximately classify debt as mostly/partially collectible or mostly uncollectible.

### **Relations between MOA, Earnings, and Arrearage Change**

Since taking a ratio can lead to extreme outliers and eliminates those with no earnings, we first looked at the distribution of arrearage debt growth over earnings and MOA as shown in Figure 3.1. For this Figure the 241,575 NCPs were categorized into 21 groups by earnings and 16 groups by MOA providing 336 cells of earnings-by-MOA classification. For the members in each cell we determined the average MOA, the average monthly earnings, and the average arrearage debt change. This shows dramatically that on average large increases in debt are associated with lower earnings and higher MOAs. The peak of the sur-

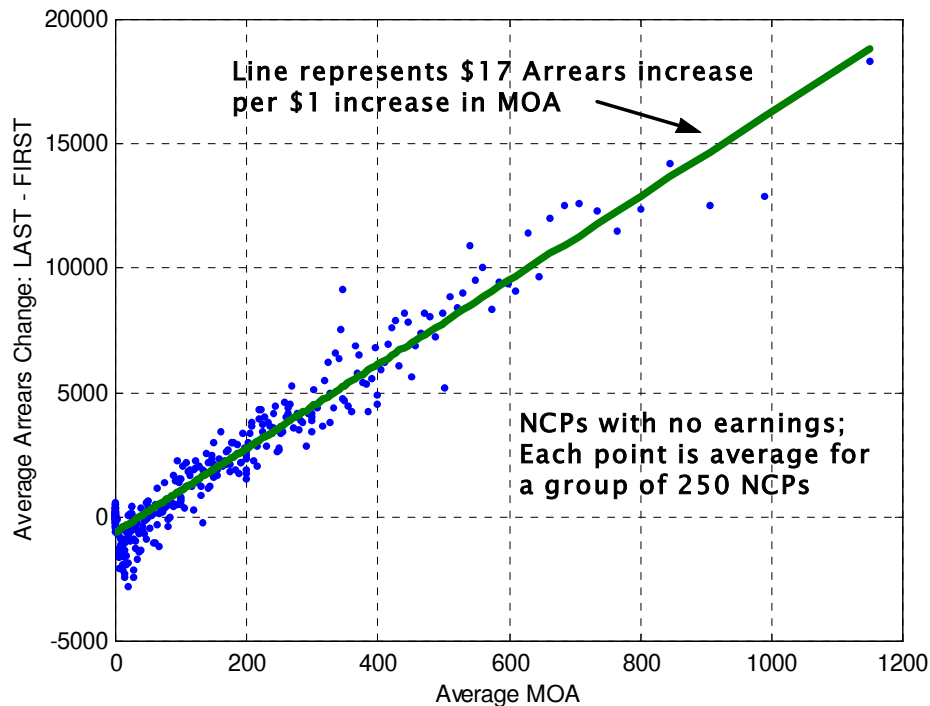
face represents an average debt increase of over \$40,000 and is associated with monthly earnings of less than \$1,000 and MOAs of more than \$1,000. On the other hand there is a region of debt decrease, which may be difficult to see on the figure, associated with higher earnings and lower MOAs. A later figure will show the region of debt decrease more clearly.

**Figure 3.1: Average Arrearage Change Related to Earnings and MOA**



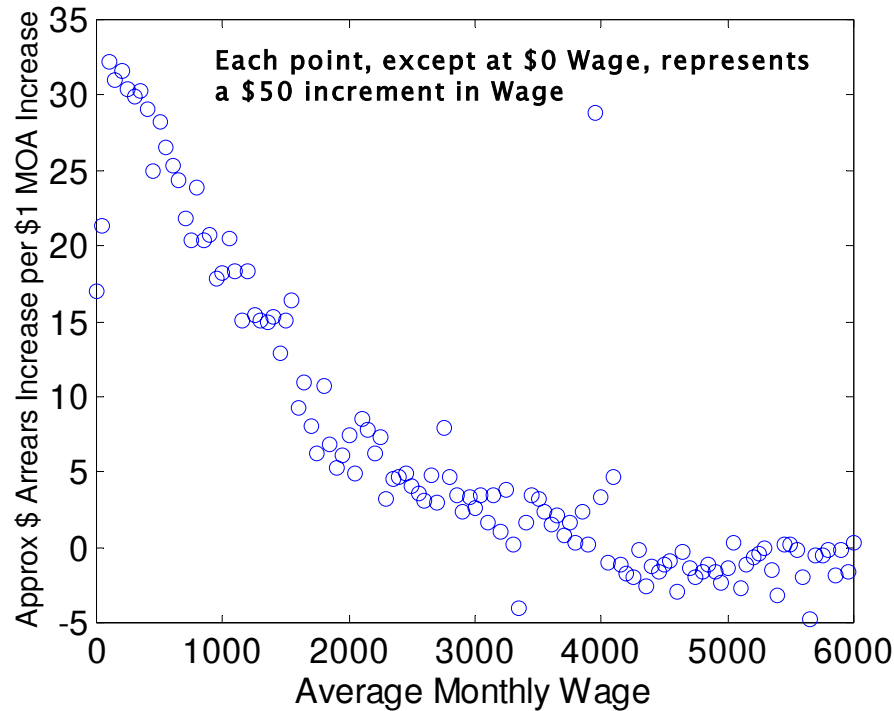
We further examine the interrelation between earnings, MOA, and debt change by seeing how debt change varies with increasing MOA at various earning levels. Figure 3.2 shows this relationship for the 88,227 NCPs who had no reported earnings during the 15 quarters, that is, their average monthly earnings were recorded as \$0. In this Figure, NCPs were placed in order of increasing MOA and then averaged in groups of 250. There is a fairly linear relationship which is summarized by the line representing a \$17 increase in arrears over the 15 quarters for each \$1 increase in MOA. This essentially gives us the steepness of Figure 3.1 in the MOA direction at \$0 average earnings.

**Figure 3.2: Arrearage Change by MOA at \$0 Earnings**



We repeat this process in \$50 increments of monthly earnings to view the approximate steepness (as \$ arrears increase per \$1 increase in MOA) of Figure 3.1 as earnings increase. This is shown in Figure 3.3. There are fewer NCPs at higher earnings and the relationship between MOA and debt is less linear than in Figure 3.2, but this still gives us useful information. The striking feature of Figure 3.3 is the high marginal arrearage cost of an increase in MOA at low earnings and the small or zero marginal cost of an increase in MOA at higher earnings.

**Figure 3.3: Marginal Arrearage Cost for MOA Related to Earnings**

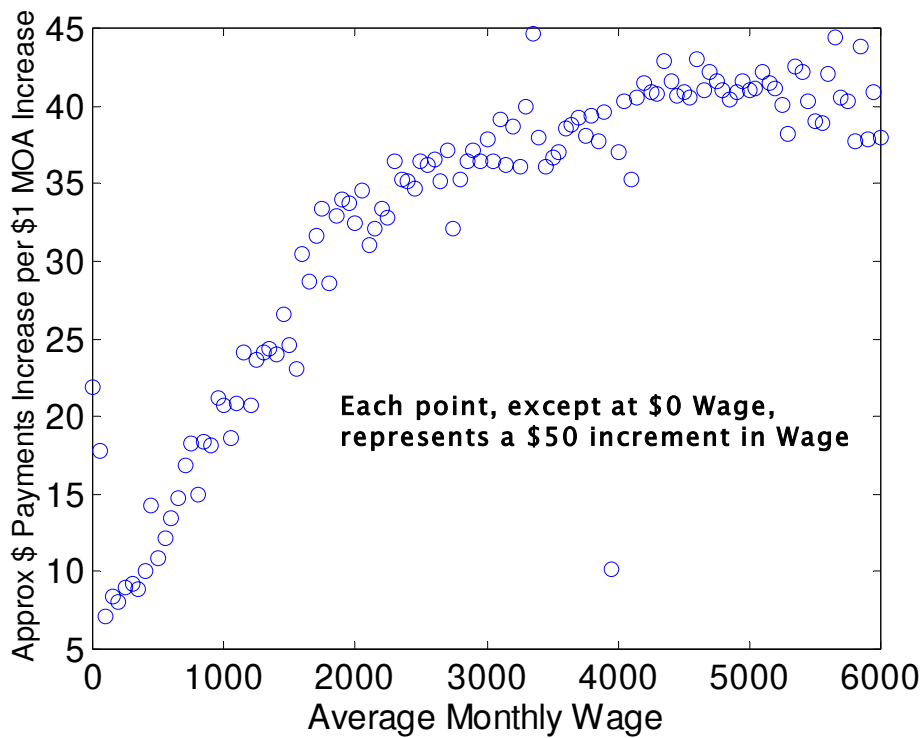


There are two anomalous features in Figure 3.3 which need to be explained. The first is the apparent rise in marginal arrearage cost from \$0 to \$100 earnings. This is because our best source of earnings data is from Employment Security Department (ESD) records, but some earnings do not have to be reported to ESD. Also we have no access to earnings information for wages paid outside of Washington State. Of NCPs with \$0 average monthly earnings 43.5 percent are involved in initiating interstate cases, that is, the NCP is not in Washington State. Eleven percent of the NCPs represented by the \$50 point in Figure 3.3 are not in Washington State. So these first few points really represent some unknown mixture of NCPs who have no, or very low, actual earnings and NCPs who have earnings, but there was no report to ESD. The second anomalous feature is the point at approximately \$4,000 earnings and \$29 marginal arrearage cost. Only 269 NCPs are included in this point; since we are averaging in groups of 250 (see Figure 3.2) this point cannot represent the underlying pattern.

From this work we can also make implications about collections. If the MOA is increased by \$1 the maximum additional collections over 15 quarters is \$45. But not all NCPs are in DCS records for the entire 15 quarters. Taking the \$50 increments established in Figure 3.3 and determining the average number of quarters for each increment we can determine the maximum marginal collections benefit from a \$1 increase in MOA for each increment. Subtracting from this the marginal arrearage cost shown in Figure 3.3 then gives us an estimate

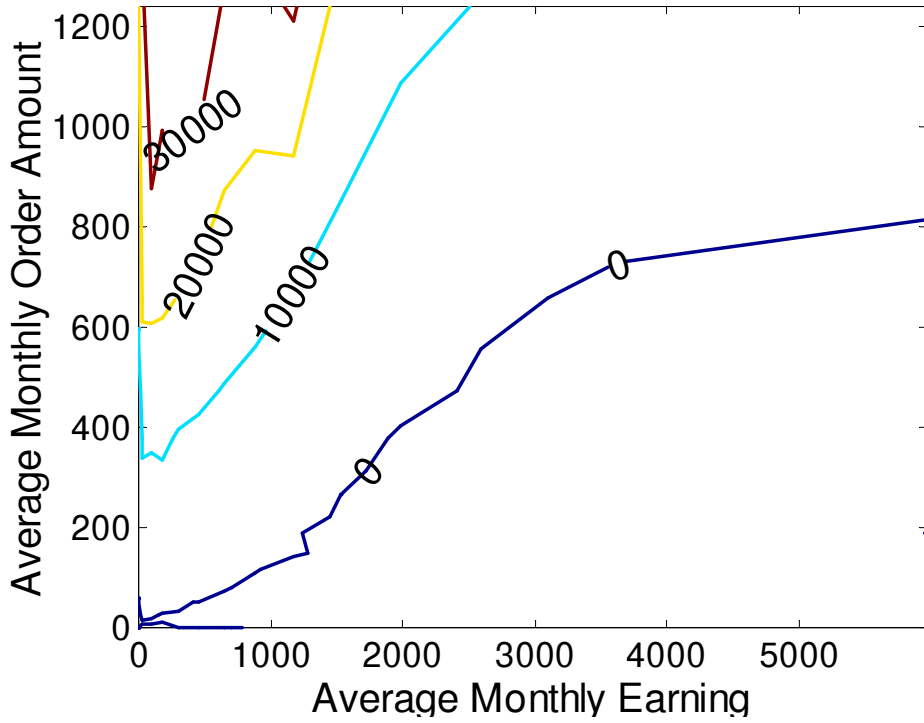
of the marginal increase in collections per \$1 increase in MOA. This is shown in Figure 3.4. At very low earnings the marginal increase in collections is small, less than \$10, while at earnings above about \$3,000 the implied collections are essentially at the maximum possible (the average number of quarters across the Figure is usually a little over 13).

**Figure 3.4: Marginal Payments Benefit for MOA Related to Earnings**

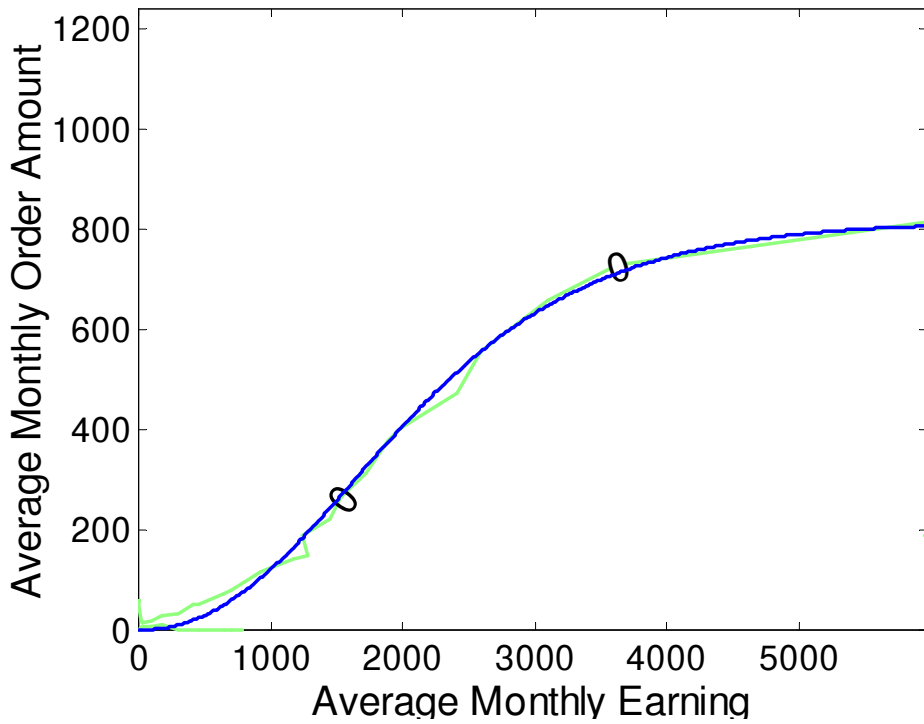


Going back to consider Figure 3.1 using a different approach, we create the contour diagram in Figure 3.5. This shows us the shape of the surface at various levels of arrearage change and clearly shows the region where, on average, decreases in arrearage occur. The contour line labeled with "0" marks the border between increasing arrearage and decreasing arrearage. To the right and below this line arrears on average decreased during the 15 quarters. We will call this line the Zero Contour, but since it is just a graphics object we will make it more useful by creating a mathematical estimation to represent this line. This is the smooth line shown in Figure 3.6 and called the Zero Contour Estimate (ZCE). This mathematical representation allows us to classify each NCP into the region with increasing arrearage or into the region of no change or decreasing arrears. Above the ZCE are 163,651 NCPs with an average arrearage change of \$3,585, while on or below the ZCE are 77,924 NCPs with an average arrearage change of - \$532.

**Figure 3.5: Contour View of Figure 3.1**



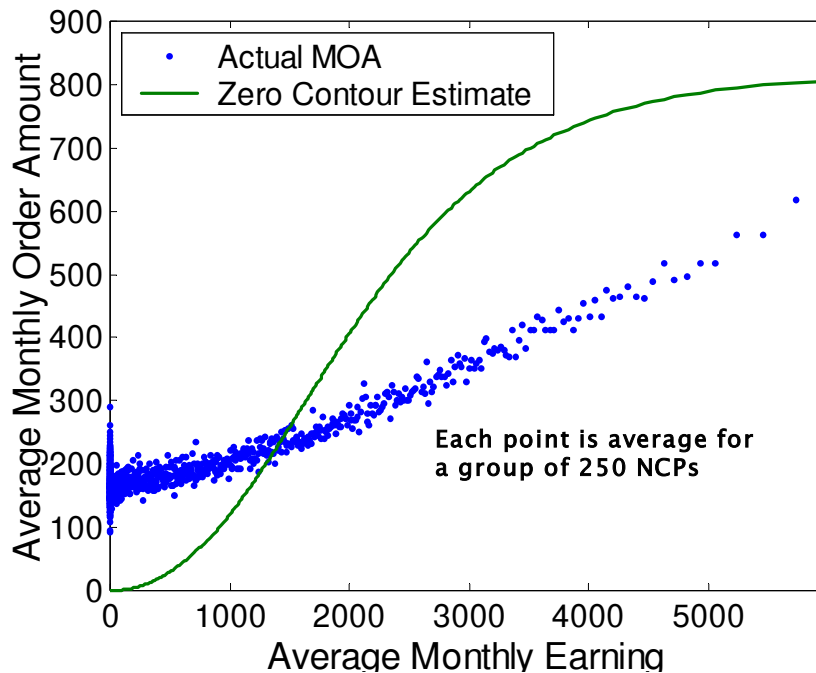
**Figure 3.6: Creating a Zero Contour Representation**





While this is useful, more information can be gained by comparing the ZCE - which is a relation between earnings and MOA - to how the MOA is actually set relative to earnings. This is shown in Figure 3.7 where for the actual MOA the NCPs are ordered by increasing earnings and averaged in groups of 250. This figure strikingly shows a region where earnings are low and where on average the MOA is set above the ZCE, and a region where earnings are high and the MOA is set below the ZCE. The cross-over point is interesting and to establish this point using all the data we create in Figure 3.8 a mathematical representation of the actual MOA data. The line in Figure 3.8 is called the Actual MOA Estimate (AME) and represents the underlying pattern of how MOA is set relative to earnings.

**Figure 3.7: Average Actual MOA Related to Earnings and Zero Contour Estimate**



**Figure 3.8: Creating a Representation of Actual MOA**

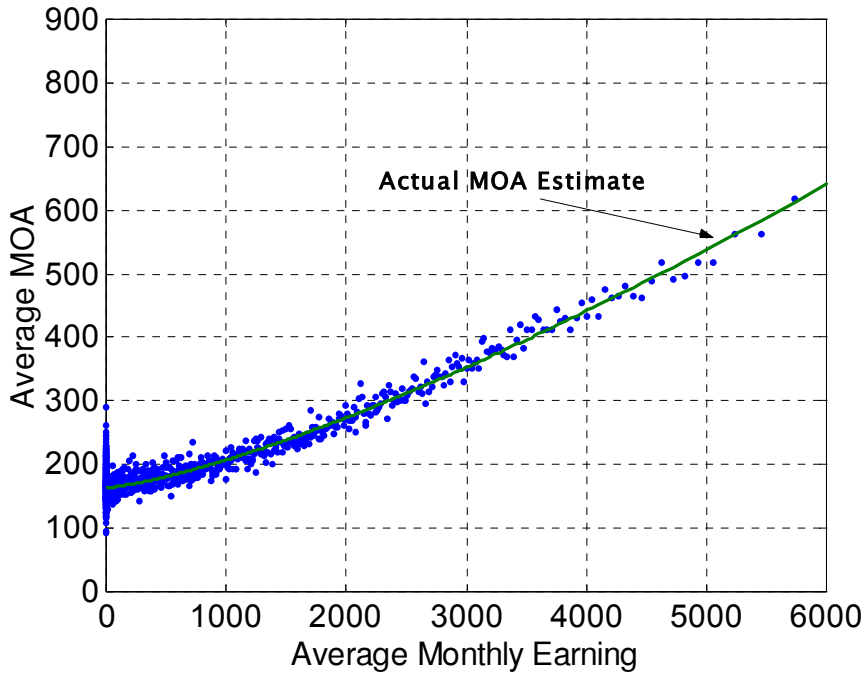
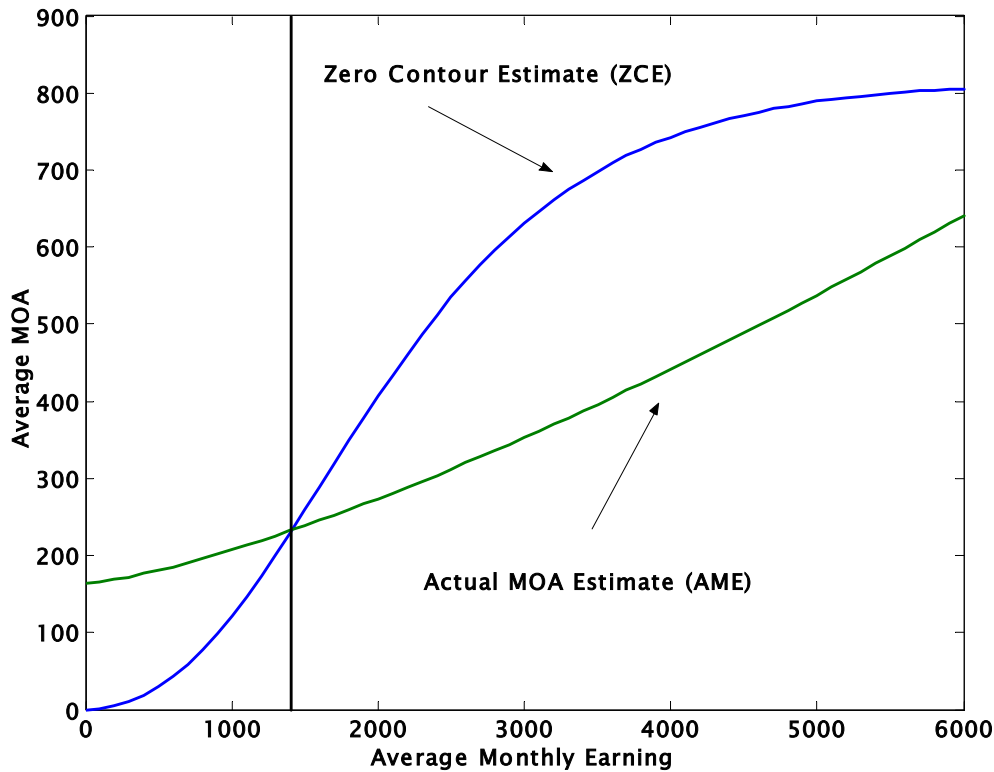


Figure 3.9 then compares the ZCE with the AME and establishes the cross-over point at about \$1,403 monthly earning. One way to view these two lines is that the ZCE represents what people can do, while the AME represents what they are being asked to do. Below \$1,400 monthly earnings they are being asked to pay more than they can and arrearages increase. Above \$1,400 monthly earnings they are being asked to pay less than they can and arrearages decrease or stay the same.

Sorensen, et al., (2002) in a study of child support debtors in California uses \$15,000 net annual income as a demarcation between those who mostly pay towards their debt, and those who largely do not. This amount is nearly equivalent to the division at \$1,400 gross monthly earnings we make in Figure 3.9.

**Figure 3.9: Comparison of Actual MOA Estimate with Zero Contour Estimate**



Equation for ZCE is

$$y = x^2 / (9568.1 - 2.7266 * x + 0.00143 * x^2)$$

Equation for AME is

$$y = 163.5 + 0.00429 * x^{1.3358}$$

where y is MOA and x is earning

Table 3.1 divides the 241,575 NCPs into four groups by earning. Those with \$0 average monthly earnings are separated out because as mentioned above they are really an unknown mixture of NCPs who actually had no income and NCPs who had income not reported in our records. The group with average monthly earnings above \$6,000 is separated out because the Zero Contour on Figure 3.5, on which the ZCE is based, is only known up to \$6,000. For the 105,707 NCPs with average monthly earnings greater than \$0 but not more than \$1,403 arrearage debt increased on average \$3,484 over the 15 quarters for a total of \$368 million. Indicating individual variability, 61.5 percent of this group had an actual increase in arrearage debt, while 25.7 percent had an actual decrease. For the 46,869 NCPs with average monthly earnings greater than \$1,403 but

not more than \$6,000 arrearage debt decreased on average \$398 over the 15 quarters for a total of - \$18.7 million. Indicating individual variability, 28.9 percent of this group had an actual increase in arrearage debt, while 71.1 percent had an actual decrease or no change in arrearage. The NCPs with earnings between \$0 and \$1,403 were expected to pay an average 40.1 percent of their earnings in MOA, while the NCPs with earnings between \$1,403 and \$6,000 were expected to pay an average 12.5 percent of their earnings in MOA. The group with earnings above \$6,000 were expected to pay an average 8.8 percent of their earnings in MOA.

**Table 3.1: Characteristics of Four Wage Regions**

	Wage Region			
	\$0	\$0 - 1403	\$1403 - 6K	> \$6K
<b>Number</b>	88,227	105,707	46,869	772
<b>d (Arrears)</b>				
<b>Avg</b>	\$2,217	\$3,484	-\$398	-\$20
<b>Sum</b>	\$196 M	\$368 M	-\$18.7 M	-\$15.4 K
<b>Percent w</b>				
<b>d&gt;0</b>	47.7%	61.5%	28.9%	18.9%
<b>d=0</b>	23.1%	12.8%	28.2%	54.1%
<b>d&lt;0</b>	29.2%	25.7%	42.9%	26.9%
<b>MOA</b>	\$170	\$181	\$322	\$795
<b>Wage</b>	\$0	\$453	\$2,567	\$9,027
<b>MTW</b>	N/A	40.1%	12.5%	8.8%

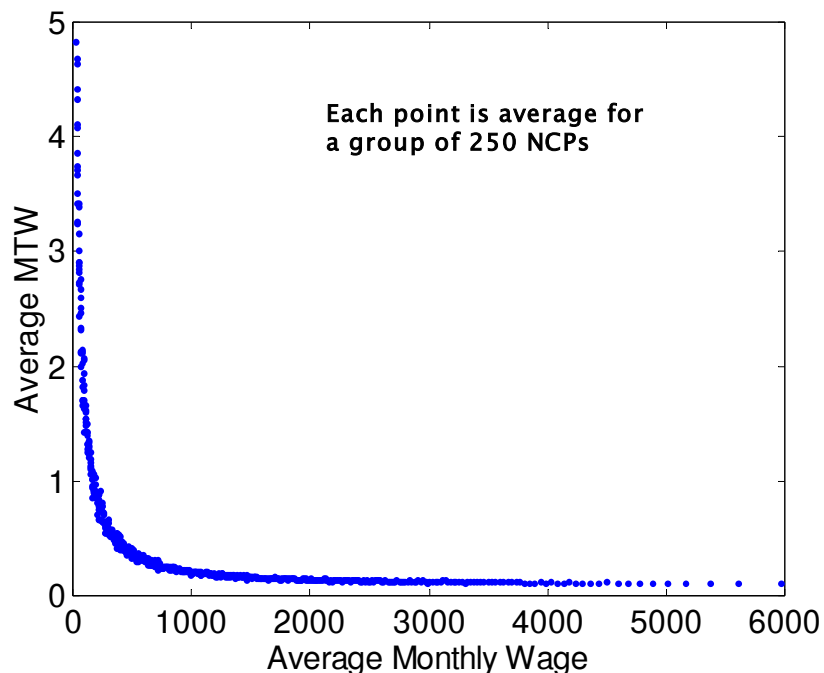
*In the first column d(Arrears) means arrears change with the next two rows giving the average and sum of arrears change in each wage region; Percent w d>0 gives the percentage of NCPs in each wage region who had an increase in arrears, d=0 gives the percentage with no change in arrears, and d<0 gives the percentage with a decrease in arrears.*

While the 40 percent vs. 12 percent of Table 3.1 suggests inequity, it vastly understates the apparent inequity in how MOA is set relative to earnings. Excluding NCPs with less than \$1 average monthly earnings we determine the ratio of MOA to wage (MTW) for each individual, order individuals by increasing monthly earnings, and then average in groups of 250.

The results are shown in Figure 3.10 where it is clear that those with lowest earnings are expected to pay an inordinate portion of their earnings. The chart is truncated at MTW = 5; the average MTW for the group of 250 NCPs with lowest earnings above \$1 per month is 130.3 - this group is on average expected to

pay 130 times their income. The group of 250 NCPs with highest earnings in Figure 3.10 has an average MTW of 0.11 - they need only pay 11 percent of their income. The data crosses the 0.5 ratio at about \$375 monthly earnings - that is anyone earning \$375 per month or less is on average obligated to pay 50 percent or more of their gross earnings in child support. The data crosses the 1.0 ratio at about \$175 monthly earning. NCPs earning only \$175 per month are on average expected to pay all of their gross monthly income in child support.

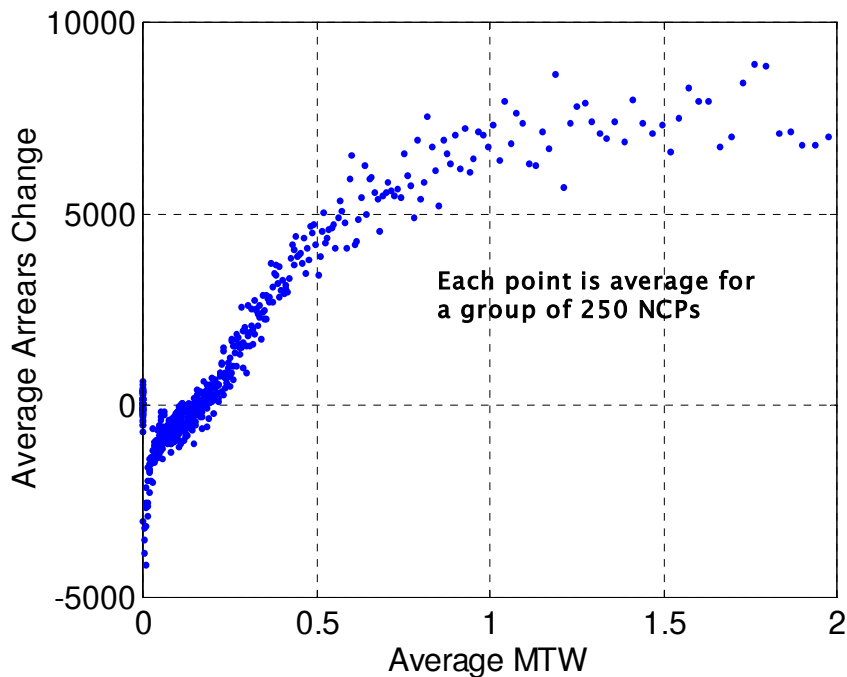
**Figure 3.10: MTW Ratio Related to Earnings**



Results are going to be disappointing with these expectations. Figure 3.11 shows how arrearage results are related to MTW and confirms that as MTW rises arrearage debt will tend to increase. In Figure 3.11 there are no NCP groups with decreasing arrearage when MTW is above 20 percent. The leveling off of arrearage change above an MTW of about 1.0 is probably due to a minimum order being set regardless of income.

The study of arrears collectibility in California (Sorensen, et al., 2003) looked only at debtors, but also found that as income dropped the ratio of child support award to income rose dramatically. At net annual income between \$60,000 and \$70,000 child support obligation was eight percent of net income, while in the net annual income range \$1 to \$5,000 child support obligation was 2.11 times net income.

**Figure 3.11: Arrearage Change Related to MTW Ratio**



### Barriers to Payment

Since NCPs may have unreported income or hidden assets we can not explicitly show that those with low reported earnings are unable to pay, but we do have strong evidence that this is the case. Our data allows us to consider the eight possible barriers to payment given in Table 3.2. When each of these barriers is viewed in relation to average monthly earnings those with lowest earnings also have an inordinate share of each of the eight barriers. Figure 3.12 shows the average number of barriers per NCP in relation to average monthly earning. Figure 3.13 shows the average MTW in relation to the number of barriers. The conclusion is inescapable that those with the most problematic lives as indicated by the barriers and the lowest incomes as indicated by ESD reported earnings, those with the least ability to pay, are being expected to pay an impossibly large portion of their income towards child support.

Discussion in Volume 2, on the case assessment study (Peters, 2003), will suggest that the situation is not outside of child support guidelines and show how such unreasonable expectations can arise.

In the California study (Sorensen, et al., 2003), with more complete income data than our study, finds debtors without recent income significantly more likely to face employment barriers and less able to pay child support. It appears from

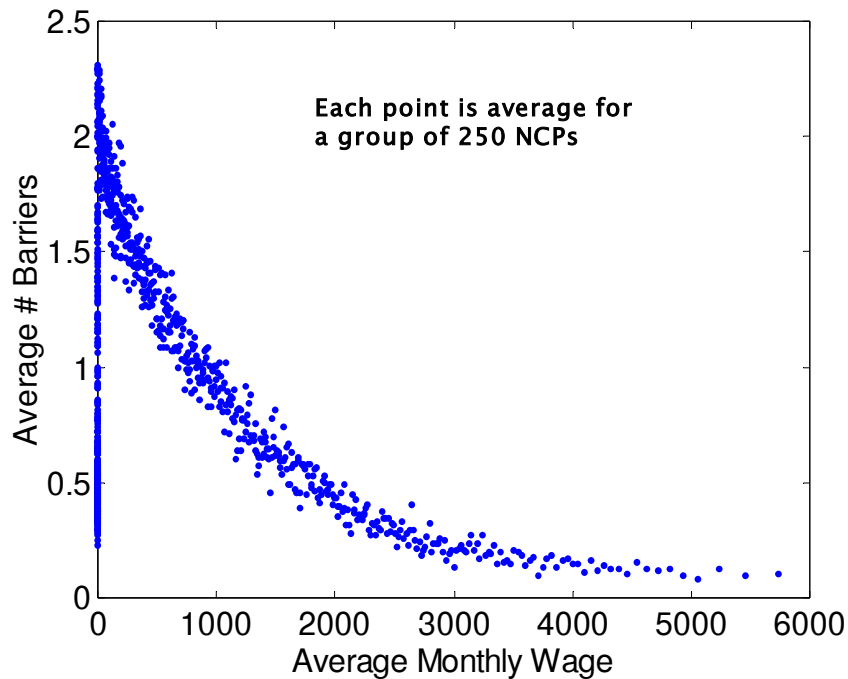
that study that the bulk of arrears debt in California is also held by those with the least ability to pay.

**Table 3.2: Barriers to Payment of Child Support**

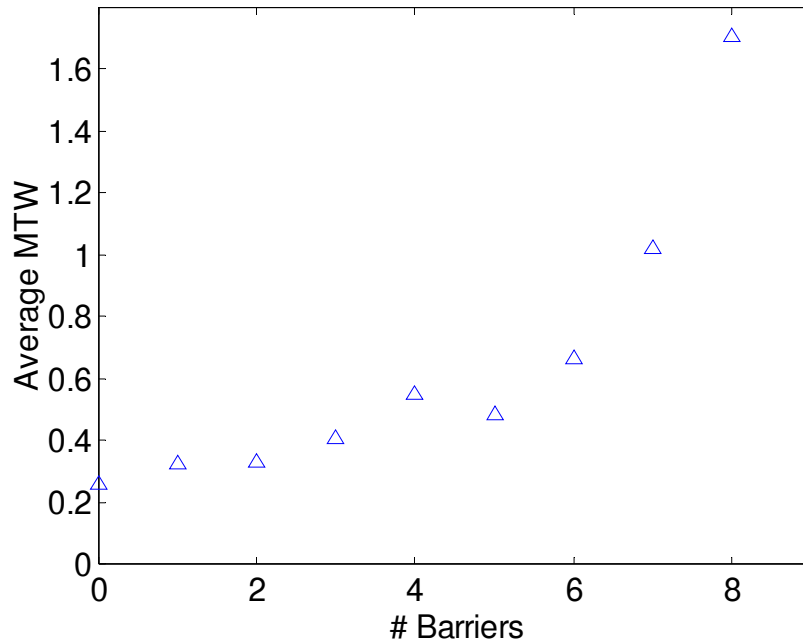
<b>Barrier</b>	<b>Data Source</b>	<b>Detail</b>
Welfare Use	Eligibility Records	Any use 93Q4-95Q3
Multiple NCP Cases	95Q3 DCS Records	More than one case
Cases as CP	95Q3 DCS Records	Any case
Limited English	95Q3 DCS Records	Language indicator
Alcohol/Substance Abuse	Cross-Program Data	Any related program
Disability	Cross-Program Data	Any related program
Food Stamps	Cross-Program Data	Any use
Public Services	Cross-Program Data	More than 2*

*\* more than 2 public services/programs after exclusion of those already listed*

**Figure 3.12: Number of Barriers per NCP Related to Earnings**



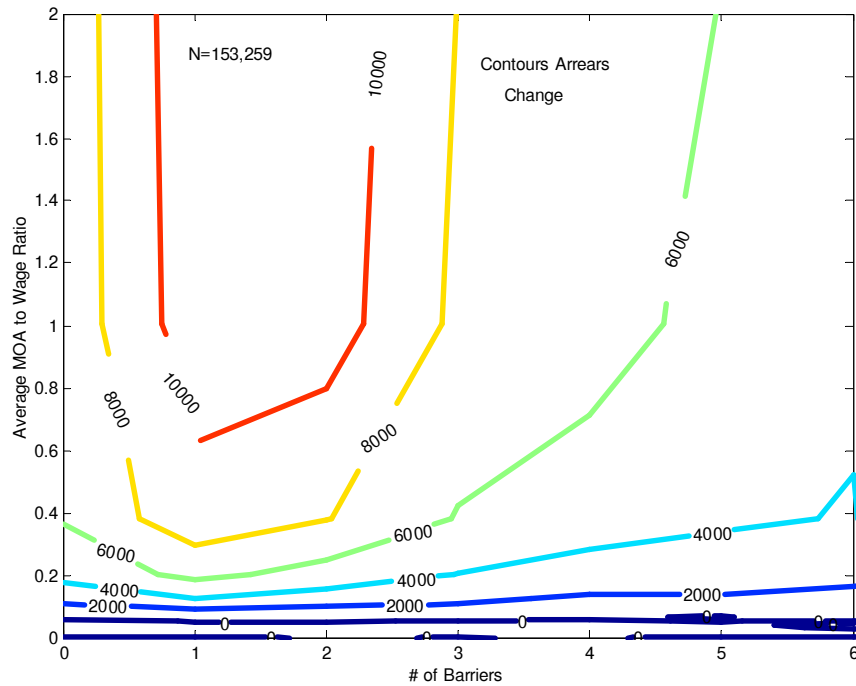
**Figure 3.13: MTW Ratio Related to Payment Barriers**



However, an interesting observation emerges when we look at the interrelationships between MTW, barriers, and arrearage change. Figure 3.14 shows a contour plot where the contours are arrears change as related to barriers and MTW. The observation is that barriers are not very important when MTW is low, but become important at higher MTW. At MTW below 0.2 the contours are almost parallel to the barriers axis, which means that as the number of barriers increases arrearage change is only slightly affected. At MTW above about 0.4 the number of barriers can have a strong influence on arrearage change. If we follow an imaginary line at MTW=0.7 across the Figure as the number of barriers increases, the average arrearage change starts off at about \$7,000, increases to \$8,000, then to \$10,000, then begins to drop off to \$8,000, and \$6,000, and ends up at about \$5,000. A drop in MOA as number of barriers increases appears to be responsible for the drop in arrearage change after about 2 barriers. The conclusion here is that even those with limited ability to pay apparently do pay child support when it is a low percentage of their monthly income. At the 8.8 percent payment required of those earning over \$6,000 per month (see Table 3.1) the number of barriers appears to have essentially no effect on arrearage behavior. At the 40 percent average payment required of those earning \$1,400 or less per month (see Table 3.1) barriers are important. The threshold where barriers begin to become important is at about 20 percent MTW.



**Figure 3.14: Arrearage Change Related to MTW and Barriers**

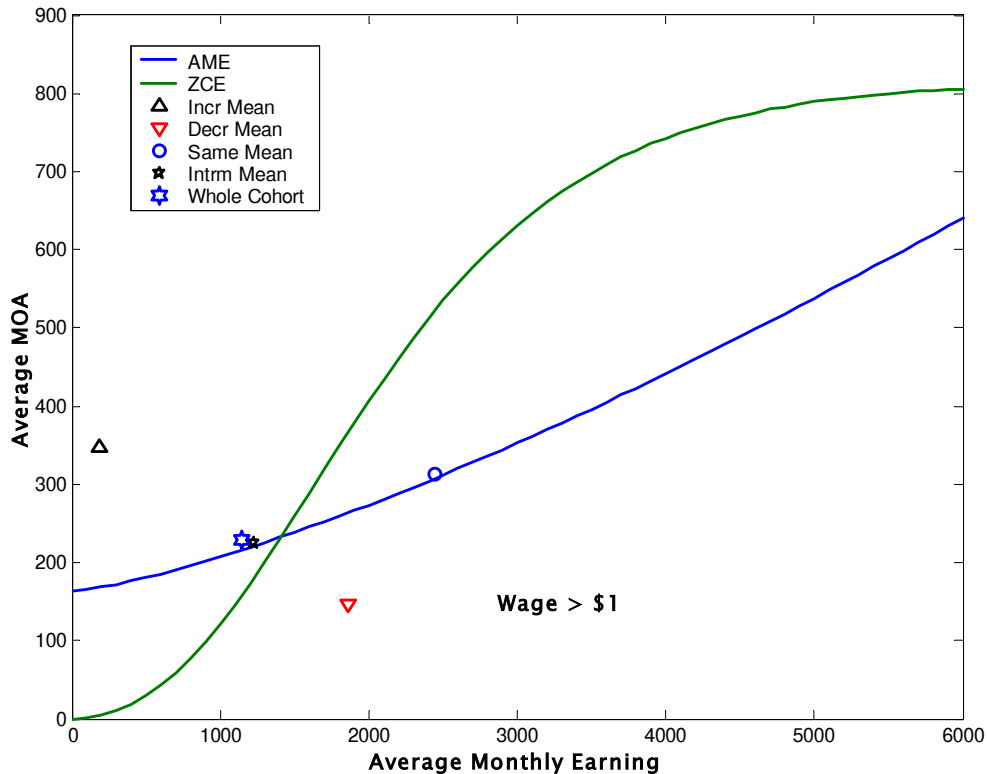


### Sample Frames for Case Assessment

Four samples were drawn by random selection for the case assessment study (Peters, 2003). The *Increasing* sample frame included all NCPs who had continuously increasing arrears, the *Decreasing* sample frame included all NCPs who had continuously decreasing arrears, and the *No Change* sample frame included all NCPs who had no change in arrears. The *Intermittent* sample frame was NCPs with at least four separate spells of arrearage behavior, including spells of increasing and/or decreasing arrearage. Appendix A1 provides additional details, as will Volume 2 (Peters, 2003) of this report.

It is interesting to see where the MOA and wage of the four sample frames are placed relative to the Actual MOA Estimate (AME, see above, - represents how MOA is set relative to earnings on average) and the Zero Contour Estimate (ZCE, see above, - represents the relation between MOA and earnings where arrears do not grow). Figure 3.15 is the same as Figure 3.9 with the average wage and average MOA included for the four sample frames and for the entire cohort. Only NCPs with wages more than \$1 per month are included since we know that those with lower income are some unknown mixture of NCPs without earnings and NCPs with unreported income.

**Figure 3.15: Location of Sampling Frames & Cohort Averages Relative to AME and ZCE**



The averages for both the *Intermittent* sampling frame and for the whole cohort are close to the AME/ZCE intersection, but in the region of increasing arrearage. For *Intermittent* the represented MTW is 0.184 and for the whole cohort the represented MTW is 0.199.

The *Increasing* sample frame has an average MOA about twice the AME and is in the region where arrearage strongly increases. The MTW represented by this point is 1.83.

The *Decreasing* sample frame has an average MOA about 55 percent of the AME and is in the region of decreasing arrears. The MTW represented by this point is 0.079 - MOA is only 7.9 percent of earnings.

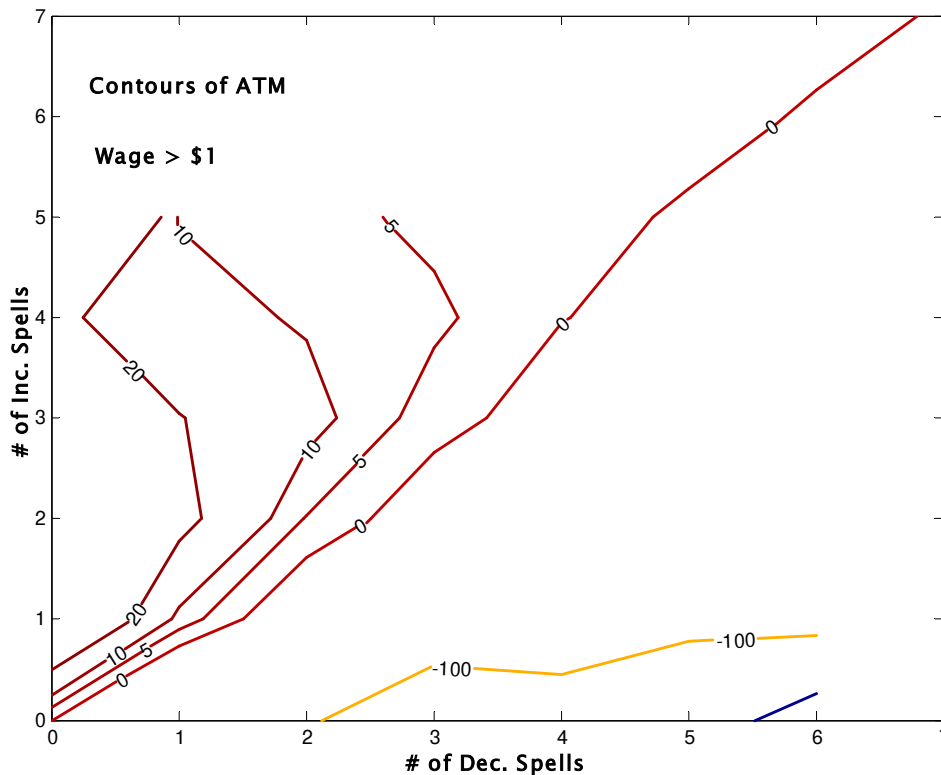
The *No Change* sample frame has an MOA very close to the AME. The MTW represented by this point is 0.128. While the point is in the decreasing region, the case level assessment (Peters, 2003) suggests that the NCPs in *No Change* are really three divergent groups: NCPs who owe current support and pay regularly

never building up arrears, NCPs who owe only arrears but never pay, and NCPs whose MOA is \$0 because they do not have an order established and thus cannot build up arrears. Eliminating NCPs who have MOA=\$0 would move the point for *No Change* closer to the ZCE but have only a small effect on MTW.

### Incorporating Spells Analysis

As discussed in Chapter 2 we have the record of arrearage spells for each NCP in the cohort. In Figure 3.16 we look at arrearage change distributed over the number of *Increasing spells* vs. the number of *Decreasing spells*. Figure 2.1 in Chapter 2 shows the same kind of chart for the number of NCPs, but Figure 3.16 only includes NCPs with monthly wages more than \$1. In this Figure we have additionally adjusted arrearage change by dividing the average arrearage change in each cell by the average MOA in each cell (we call this the Arrears to MOA ratio - ATM). This gives the approximate number of missed payments over the 15 quarters.

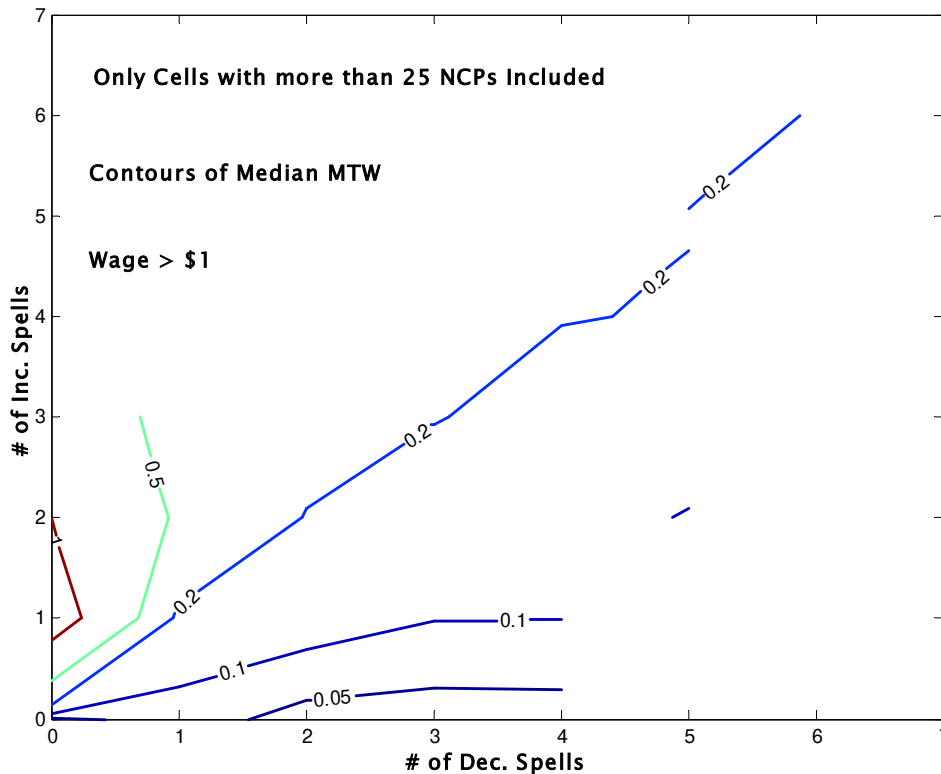
**Figure 3.16: Approximate Number of Missed Payments Related to Number of Increasing Spells and Number of Decreasing Spells**



The locus of zero missed payments is approximately on the line where the number of *Increasing spells* is equal to the number of *Decreasing spells*. Below four *Decreasing spells* the zero contour is slightly below equality (less than one *Increasing spell* per *Decreasing spell*), and above four *Decreasing spells* the zero contour is slightly above equality (more than one *Increasing spell* per *Decreasing spell*). As the number of *Increasing spells* increases relative to *Decreasing spells* more missed payments are seen. As the number of *Decreasing spells* increases relative to *Increasing spells* decreasing arrearage is seen. The -100 contour indicates that some individuals are 100 payments (or more) ahead over the 15 quarters.

In Figure 3.17 we make the same kind of plot with MTW. Here we use median MTW because with small numbers of individuals in some cells the average MTW is unstable.

**Figure 3.17: MTW Related to Number of Increasing Spells and Number of Decreasing Spells**



We see that the contour of 20 percent MTW also falls very close to the line where the number of *Increasing spells* is equal to the number of *Decreasing spells*, and

where Figure 3.16 shows no missed payments. When MTW is above 20 percent there will be more *Increasing spells* than *Decreasing spells*, more payments will be missed, and arrears will tend to increase. Comparing Figure 3.17 with Figure 3.16, 50 percent MTW corresponds to about 20 or more missed payments over the 15 quarters. When MTW is less than 20 percent there will be more *Decreasing spells* than *Increasing spells*, payments will not be missed, will in fact be larger than the MOA, and arrears will tend to decrease.

Finally we restrict our consideration to only those NCPs with wages more than \$1 who also have only sequence patterns with *Increasing spells* and *Decreasing spells*. This means the NCPs we are now considering cycle between increasing arrears and decreasing arrears with no *NoChange spells* and no *UnDetermined spells*.

Figure 3.18 shows how the MTW and ATM relate for those NCPs who started the cycle with an *Increasing spell*. In this Figure a total number of spells of 1 would mean continually increasing arrears, and a total number of spells of 2 would mean a spell of increasing arrears followed by a spell of decreasing arrears. Thus an odd number of total spells would be ending on a spell of increasing arrears while an even number of spells would be ending on a spell of decreasing arrears - and the number of *Increasing spells* would be equal to the number of *Decreasing spells*. We see that for an odd number of spells both the MTW and ATM are high while for an even number of spells both the MTW and ATM are low.

**Figure 3.18: MTW and ATM Follow the Same Pattern for NCPs with Only Increasing and Decreasing Spell Sequences Which Begin with an Increasing Spell**

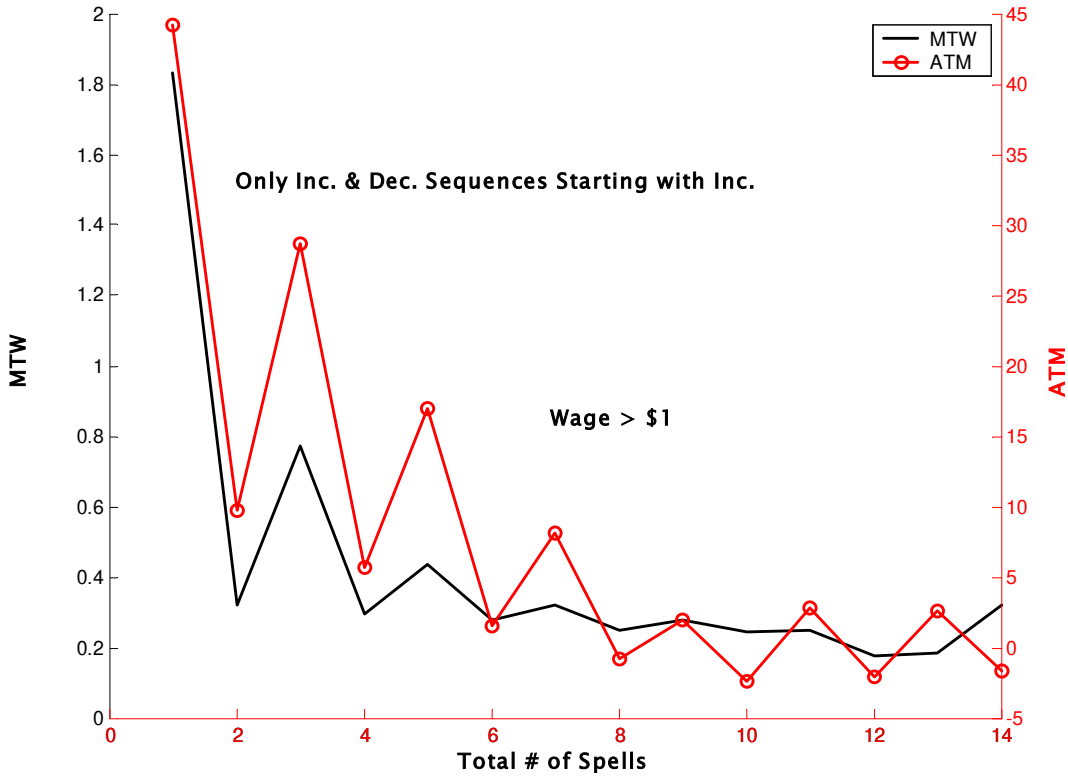
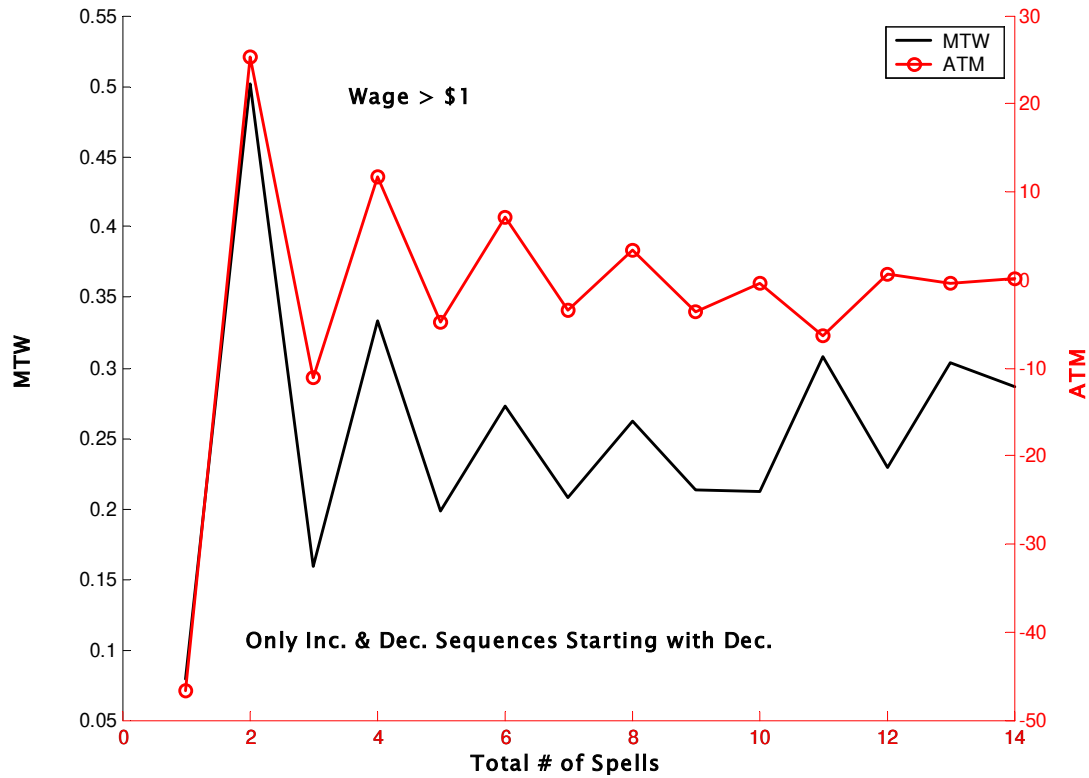


Figure 3.19 shows how the MTW and ATM relate for those NCPs who started the cycle with a *Decreasing spell*. In this Figure a total number of spells of 1 would mean continually decreasing arrears, and a total number of spells of 2 would mean a spell of decreasing arrears followed by a spell of increasing arrears. Thus an odd number of total spells would be ending on a spell of decreasing arrears while an even number of spells would be ending on a spell of increasing arrears - and the number of *Increasing spells* would be equal to the number of *Decreasing spells*. This is why we separated these NCPs into two groups. In this Figure we see that for an odd number of spells both the MTW and ATM are low while for an even number of spells both the MTW and ATM are high. For odd numbers of spells the ATM is below 0 and the MTW is 20 percent or below up to the ninth spell where the number of NCPs becomes very small.

**Figure 3.19: MTW and ATM Follow the Same Pattern for NCPs with Only Increasing and Decreasing Spell Sequences Which Begin with a Decreasing Spell**

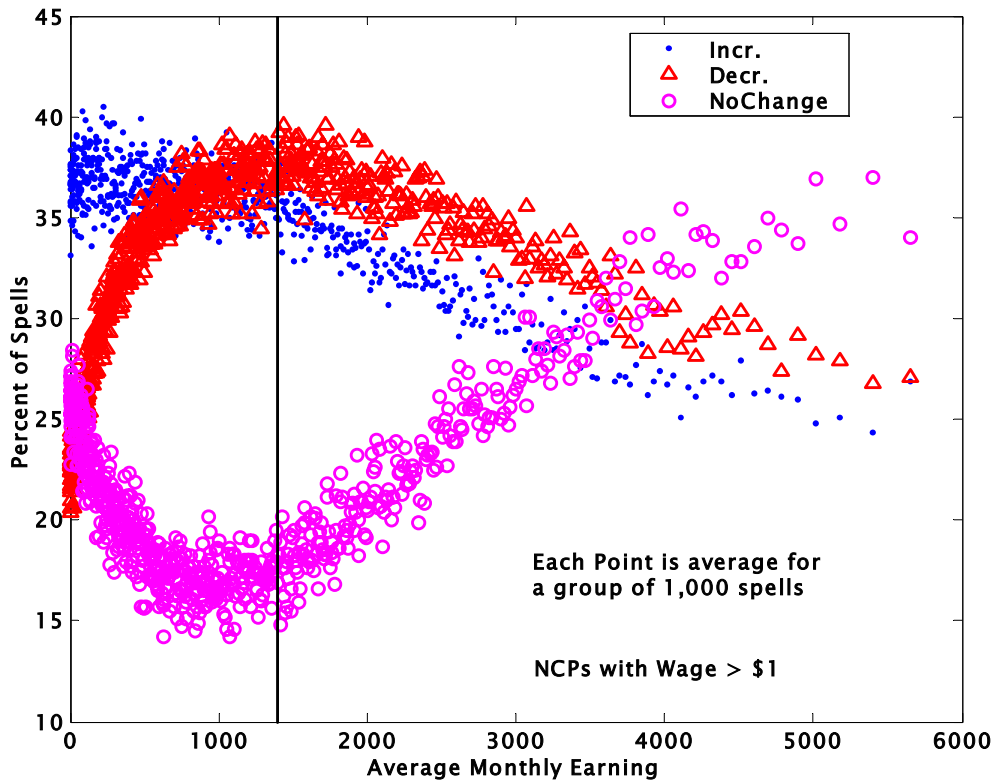


In part what we see in these last two figures is a result of our limited observation time - those who end the 15 quarter observation on a *Decreasing spell* are likely to have lower arrears than those who end the period on an *Increasing spell*. But Figures 3.18 and 3.19 do suggest the importance of MTW in understanding the cycle of *Increasing spells* and *Decreasing spells*. If the MTW is very high - 1.83 in Figure 3.18 for the 7,568 NCPs with only one *Increasing spell* - the NCP will never be able to have a succeeding *Decreasing spell*, and will likely never be able to even make a complete payment of the MOA. If the MTW is lower the *Increasing - Decreasing* spell cycle may begin with the NCP building up arrearage for a while and then paying it down. It is clear that this cycle will be more favorable the lower the MTW. It will simply be easier for the NCP to pay the MOA and to pay extra to reduce arrearage. The 1,825 NCPs with continually decreasing arrearage in Figure 3.19 have an MTW of 0.079 and an ATM of -46.6; over the 15 quarters they have paid more than twice their MOA. The 1,892 NCPs with spell sequence *Decreasing - Increasing - Decreasing* have an MTW of 0.159 and an ATM of -11.1; over the 15 quarters they have paid 11 extra payments of their MOA. On the other hand the 1,337 NCPs with spell sequence *Decreasing -*

*Increasing* have an MTW of 0.501 and an ATM of 25.4. They are expected to pay 50 percent of their gross income towards child support and are not able to get ahead of the arrearage growth of their *Increasing spell*, missing about 25 MOA payments over the 15 quarters. Chapter 2 showed that this creates a serious problem; 32 percent of the NCPs had an *Increasing spell* until the end of observation and accounted for 45 percent of the total cost of increasing spells.

We next place NCPs in order of increasing earnings and examine the dynamic composition of arrearage debt as gross monthly earnings change from \$1 to \$6,000. Figure 3.20 shows the percentage of *Increasing*, *Decreasing*, and *NoChange* spells across this earning span.

**Figure 3.20: Percentage of Spell Types Related to Earnings**



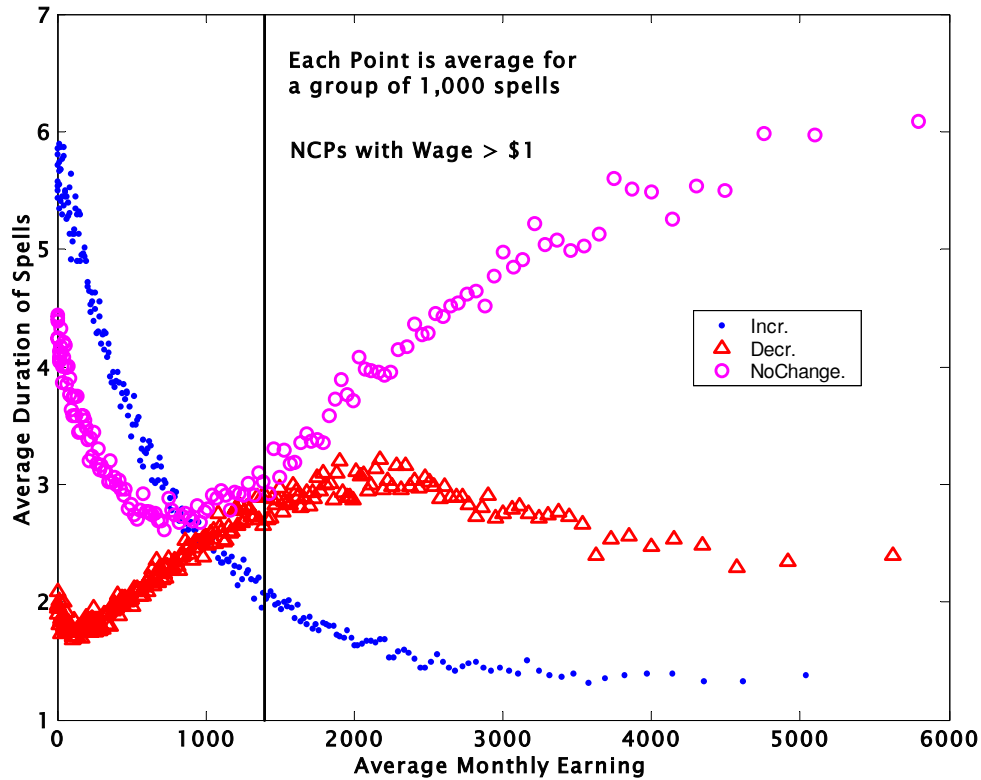
The peak in percent *Decreasing* spells is very close to the \$1,400 threshold identified in Figure 3.9. Above this threshold many NCPs do not build up arrears and thus cannot decrease arrears. Below this threshold many NCPs cannot even fulfill their obligation for current support, let alone decrease arrears.

Spell durations and costs also change with earnings, particularly for *Increasing* spells. As earnings decrease from \$6,000 the average duration of an *Increasing* spell rises from a little over one quarter to almost six quarters (Figure 3.21),

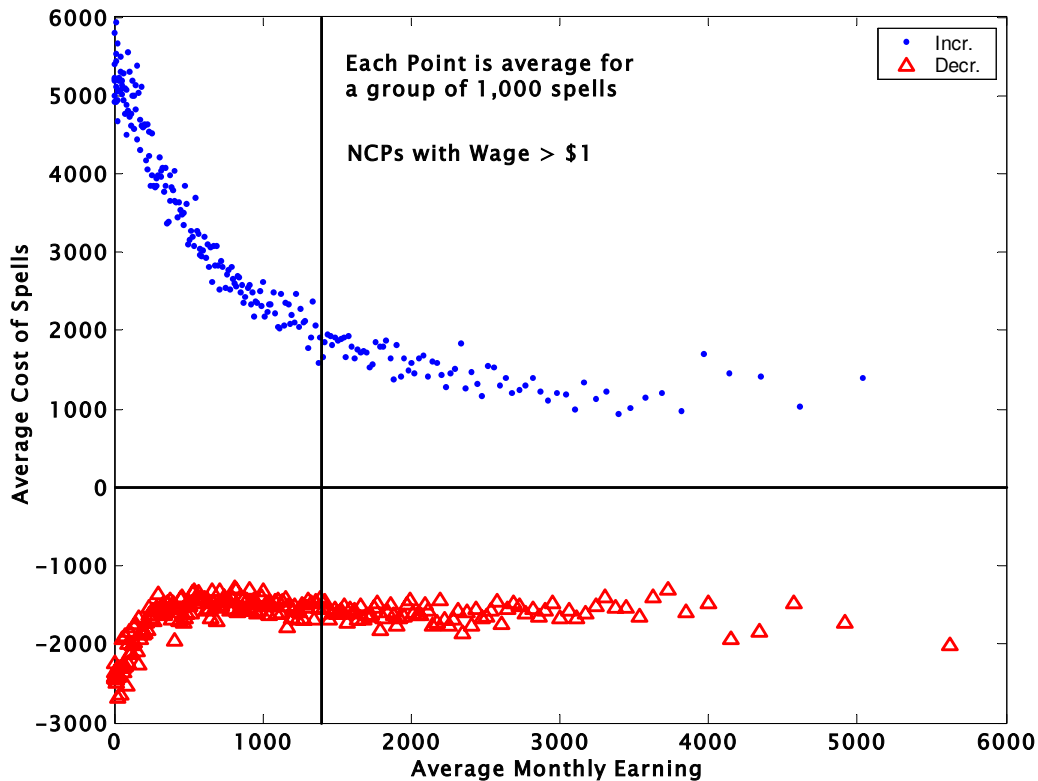


while the average cost of an *Increasing* spell rises from a little over \$1,000 to almost \$6,000 (Figure 3.22).

**Figure 3.21: Duration of Spells Related to Earnings**



The duration and cost of *Decreasing* spells show the least change as earnings change. The cost savings from a *Decreasing* spell is almost constant from a little under \$500 to nearly \$6,000 earnings (Figure 3.22). The cost and duration effects at earnings below \$500 are interesting and probably arise because NCPs with small decreases and short spells are no longer able to have a *Decreasing* spell. But these effects do indicate that some NCPs with very low reported earnings are paying down arrears. This will be further discussed in the final section of this chapter.

**Figure 3.22: Cost of Spells Related to Earnings**

The dynamic composition of debt varies continuously as earnings change, but we will consider debt composition in five segments of Figures 3.20 and 3.21.

Above \$4,000 gross monthly earnings *NoChange* spells predominate and their average duration is much longer than the duration of *Increasing* or *Decreasing* spells. The pattern here seems to be long spells of *NoChange* interspersed with less frequent short *Decreasing* spells and very short *Increasing* spells.

Between \$3,000 and \$4,000 gross monthly earnings the three spell types occur about equally, but *NoChange* spells still have the longest duration, with short *Decreasing* spells and very short *Increasing* spells. In this segment a common debt pattern may be a long spell of *NoChange* followed by a short *Increasing* spell, followed by a somewhat longer *Decreasing* spell as debt is paid down, followed again by a long spell of *NoChange*.

Between \$1,400 and \$3,000 gross monthly earnings *Decreasing* spells predominate and *NoChange* spells decrease in frequency as earnings decrease. And while the order of duration is the same as in the previous two segments, the duration of *Increasing* spells is increasing and the duration of *NoChange* spells is decreasing as earnings decrease. In this segment NCPs appear to be cycling

through short *Increasing* and *Decreasing* spells with less frequent, but longer, *NoChange* spells interspersed.

Between \$1,400 and \$500 gross monthly earnings the duration of the three spell type are about the same, but *NoChange* spells occur with about half the frequency of *Increasing* or *Decreasing* spells. In this segment a common debt pattern may be the sequence *Increase, Decrease, Increase, Decrease, NoChange*, with spells about 2.5 quarters in duration. But Figure 3.22, and other information presented in this chapter, tells us that costs will not balance; overall there will be an increase in arrearage.

Finally, between \$1 and \$500 gross monthly earnings *Increasing* spells totally predominate in frequency, duration, and cost. The duration of *Decreasing* spells does not change much but the frequency drops precipitously as earnings decrease. In this segment NCPs mainly have long and expensive *Increasing* spells interspersed with occasional and short *NoChange* spells and more frequent, but shorter, *Decreasing* spells.

### **MOA Threshold**

There are a number of indications that an MOA set above about 20 percent of earnings will begin to cause problems with arrearage debt. Figure 3.11 shows that no group of NCPs with MTW greater than 20 percent has decreasing arrears. Figure 3.14 suggests that barriers to payment become increasingly important above 20 percent MTW. Figure 3.17 suggests that above 20 percent MTW arrearage debt grows as the number of spells of increasing debt becomes greater than the number of spells of decreasing debt. Figure 3.19 suggests that a sequence of increasing and decreasing spells is more likely to end on a decrease when the MTW is 20 percent or lower. The case assessment findings also suggest the 20 percent threshold (Peters, 2003). Yet Figure 3.10 shows that many NCPs have a MTW greater than 20 percent. Of the 152,667 NCPs with wages more than \$1 included in Figure 3.10, 74,137, or 48.6 percent, have a MOA greater than 20 percent of their reported earnings.

This threshold is very much in line with a recent report from the DHHS Office of Inspector General (OIG, 2002). That report concluded that the methods used to set orders for low income noncustodial parents often yielded high orders and poor compliance. They used a random sample of 270 noncustodial parents drawn from ten states. Noncustodial parents below the poverty line were found to have orders amounting to 69 percent of their income. The study also found that when orders were 15 percent or less of income compliance was 61 percent, but when orders were more than 20 percent of income compliance was 20 percent.

## Debt Collectibility

The information presented in this chapter allows us to begin making estimations of debt collectibility, and suggestions of strategies for debt management. Most of the debt growth during the 15 quarters of this study is from NCPs with reported monthly earnings of less than about \$1,400. On average the low earning NCPs also are ordered to pay a substantially larger portion of their income in child support, while at the same time they have substantially more barriers in their ability to pay. The conclusion is that low earning NCPs are on average simply not able to pay the ordered level of child support.

However, within the low earning NCPs there are many NCPs whose arrears do not increase. These will generally be NCPs with no barriers and/or MTWs below about 20 percent. Information on MOA, earnings, barriers and arrearage history can be used to begin determining where the debt may be partially collectible, and where the debt would be mostly uncollectible. If there is debt growth with low income but no payment barriers this may suggest hidden income and a debt that is at least partially collectible. If there is debt growth with low income, a high MTW, and payment barriers this almost certainly suggests a debt that is mostly uncollectible.

Sorensen, et al., 2003 create a debt collectibility classification scheme based on the age of the debt, the location of the debtor, and the debtor's ability to pay. It would be interesting to integrate their approach with ours.

We will consider three wage regions: monthly wages \$1 or less, monthly wages more than \$1 but less than \$1,400, and monthly wages \$1,400 or more but less than \$6,000. Since we do not have complete information on NCPs who do not reside in Washington State we eliminate those NCPs whose record indicates they are out of state. The biggest difference in barriers is between those who have none and those who have any (see Fig. 3.14). We thus form subgroups who have no barriers to payment, and subgroups who do have one or more barriers. Then within subgroups we compare those whose debt grew during the 15 quarters with those whose debt did not grow. Tables 3.3.a - c show the results. Unless stated otherwise all differences discussed are statistically significant at the  $p < 0.05$  level.

In the \$1 or less wage region (Table 3.3.a) 50,442 NCPs resided in state. Of these 28,967 (57.4 percent) had no payment barriers. Of these 17,979 (62.1 percent) did not have a debt growth while 10,988 (37.9 percent) did. While MTW cannot be determined for this wage region, the average MOA for those with debt growth is higher than for those without debt growth. But with no barriers to payment, and presumably no barriers to earning, \$0 reported earnings becomes suspicious. Also the ATM of 28.9 indicates that many payments have been made (a maximum of 45 current payments were possible, they missed 29). For

this group of 10,988 NCPs debt grew by \$78.4 million and may encompass debt that could have been collectible.

In the \$1 or less wage region (Table 3.3.a) 21,475 NCPs (42.6 percent) did have payment barriers. But still 9,186 (42.8 percent) of these did not have debt growth even though they have over two payment barriers on average. The low MOA of \$79 may be partially responsible. The 12,289 NCPs (57.2 percent) with debt growth had more than double the MOA and 2.6 payment barriers on average. This group had a debt growth of \$95.1 million, but this debt would probably be mostly uncollectible because of the high number of payment barriers, the relatively high MOA, and the very high ATM of 40.9 which indicates that almost all of the payments due from this group have been missed.

**Table 3.3.a: Groupings for Lowest Wage Category\***

Monthly Wage \$1 or less									
Group	N	avg m	avg w	avg d	avg b	MTW	ATM	Totd, \$M	
all	88,908	\$170	\$0	\$2,232	0.71	-	13.2	\$198.5	
in state	50,442	\$174	\$0	\$2,361	1.05	-	13.5	\$119.1	
no barriers	28,967	\$198	\$0	\$1,631	0.00	-	8.2	\$47.3	
no debt incr	17,979	\$168	\$0	-\$1,730	0.00	-	-10.3	-\$31.1	
debt incr	10,988	\$247	\$0	\$7,131	0.00	-	28.9	<b>\$78.4</b>	
barriers	21,475	\$142	\$0	\$3,344	2.45	-	23.5	\$71.8	
no debt incr	9,186	\$79	\$0	-\$2,530	2.21	-	-31.9	-\$23.2	
debt incr	12,289	\$189	\$0	\$7,736	2.64	-	40.9	<b>\$95.1</b>	

*\* N is number of NCPs, m is MOA, w is monthly wage, d is arrearage debt growth, b is number of barriers, MTW is here calculated as avg m divided by avg w, ATM is here calculated as avg d divided by avg m and approximates the number of missed payments, Totd is total arrearage growth in \$ millions calculated as N times avg d. Dashed bold border indicates mostly/partially collectible, solid bold border indicates mostly uncollectible.*

In the wage region between \$1 and \$1,400 (Table 3.3.b) 98,282 NCPs were in state, with 39,929 (40.6 percent) having no payment barriers. Of those with no barriers 17,165 (43.0 percent) did not have debt growth and 22,764 (57.0 per-

cent) did have debt growth. While the MTW of 0.47 for those with debt growth is considerably higher than the 0.24 for those without debt growth, the ATM of 26.4 indicates that many payments were received from this group during the 15 quarters. Thus we consider that the total debt growth of \$147.2 million for this group may encompass debt that could have been collectible.

In the wage region between \$1 and \$1,400 (Table 3.3.b) 58,353 NCPs (59.4 percent) did have payment barriers. Of these 20,745 (35.6 percent) did not have debt growth while 37,608 (64.4 percent) did have debt growth. While there is no statistically significant difference in the average number of barriers for these two groups, there is an enormous and significant difference in MTW. Those whose debt did not grow were expected to pay only 17 percent of their income towards child support, while those with debt growth were expected to pay 60 percent of their income. The ATM of 35.6 indicates that a few payments did come in from the group with debt growth, but we would have to classify the total debt growth of \$279.0 million as mostly uncollectible.

**Table 3.3.b: Groupings for Mid Wage Category\***

Monthly Wage more than \$1 but less than \$1,400

Group	N	avg m	avg w	avg d	avg b	MTW	ATM	Totd, \$M
all	104,925	\$182	\$455	\$3,483	1.36	0.40	19.2	\$365.5
in state	98,282	\$181	\$468	\$3,456	1.39	0.39	19.1	\$339.6
no barriers	39,929	\$203	\$561	\$2,778	0.00	0.36	13.7	\$110.9
no debt incr	17,165	\$149	\$618	-\$2,114	0.00	0.24	-14.2	-\$36.3
debt incr	22,764	\$245	\$518	\$6,466	0.00	0.47	26.4	\$147.2
barriers	58,353	\$165	\$404	\$3,920	2.35	0.41	23.7	\$228.7
no debt incr	20,745	\$87	\$503	-\$2,424	2.36	0.17	-27.8	-\$50.3
debt incr	37,608	\$208	\$349	\$7,419	2.34	0.60	35.6	\$279.0

\* see Table 3.3.a footnote for definitions

Finally in the \$1,400 to \$6,000 wage region (Table 3.3.c), where debt on average decreases, there are some NCPs who do have debt growth over the 15 quarters. Of the 46,567 in state NCPs 35,056 (75.3 percent) did not have payment barriers while 11,511 (24.7 percent) did. Of those without barriers only 9,751 (27.8 percent) had a growth in debt over the 15 quarters. But the average MTW is only 15 percent of income, and the ATM of 7.9 indicates that almost all payments

due have been made. The total debt growth of \$28.9 million would clearly be mostly collectible.

Of those with barriers in the \$1,400 to \$6,000 wage region (Table 3.3.c) only 3,715 NCPs (32.3 percent) show debt growth. But the average number of barriers is low, only 1.3, the MTW is only 16 percent of income, and the ATM of 14.3 indicates that most of the payments due have been made. So, even though these are NCPs with barriers, they earn a reasonable income and their required payments are relatively low. While within the 3,715 NCPs in this category 471 (12.7 percent) do have an MTW of 30 percent or more, and 729 (19.6 percent) do have two or more barriers to payment, only 81 (2.2 percent) have both an MTW of 30 percent or more and two or more barriers. The total debt of \$18.6 million would be classified as mostly collectible.

**Table 3.3.c: Groupings for High Wage Category\***

Monthly Wage \$1,400 or more but less than \$6,000

Group	N	avg m	avg w	avg d	avg b	MTW	ATM	Totd, \$M
all	46,970	\$321	\$2,564	-\$397	0.33	0.13	-1.2	-\$18.7
in state	46,567	\$322	\$2,567	-\$396	0.33	0.13	-1.2	-\$18.4
no barriers	35,056	\$335	\$2,672	-\$392	0.00	0.13	-1.2	-\$13.7
no debt incr	25,305	\$319	\$2,755	-\$1,686	0.00	0.12	-5.3	-\$42.7
debt incr	9,751	\$377	\$2,458	\$2,966	0.00	0.15	7.9	\$28.9
barriers	11,511	\$281	\$2,247	-\$409	1.33	0.13	-1.5	-\$4.7
no debt incr	7,796	\$248	\$2,294	-\$2,996	1.34	0.11	-12.1	-\$23.4
debt incr	3,715	\$351	\$2,149	\$5,020	1.31	0.16	14.3	\$18.6

\* see Table 3.3.a footnote for definitions

Thus by considering the wage region, payment barriers, the MTW, and the ATM we can begin to segregate NCPs with debt growth into classes of mostly uncollectible or mostly/partially collectible. Some of these classifications might, of course, be wrong. In this part of our study we are using data on only eight barriers, and there are other barriers, particularly corrections records, which might be important. For the case assessment sample Department of Corrections information was obtainable from case records (Peters, 2003). For debt classified as uncollectible in the lowest two wage categories 150 NCPs were in the case assessment sample and 79, or 53 percent, had corrections records. For debt

classified as collectible in the lowest two wage categories 65 NCPs were in the case assessment sample and 28, or 43 percent, had corrections records. In the highest wage category only 15 NCPs were in the case assessment sample and only one had a corrections record. Also we are using group averages, and some individuals within the group might be far from average. A better classification would require more information and a more detailed examination of individual records. This is beyond the scope of our present study.

While refinements are possible, our preliminary classification is a good start. The two classes defined should clearly be treated differently with different approaches and strategies. Aggressive collection techniques will probably not prove fruitful with low earning NCPs who have barriers to payment, a high MTW, and a history of no payment reflected by a high ATM. The major part of debt growth for in-state NCPs falls into this classification with \$374.1 million in debt growth in the two lowest earning categories. Multiple barriers are a reasonable confirmation of low earning power, but other low earners with multiple barriers do pay when MTW is low (see bottom two entries in Table 3.3.b). The best first strategy here would probably be a modification to set MOA appropriate for earnings. This could slow or stop arrearage growth. Possibly some of the accumulated arrearage could be written off. Finally a detailed look at the actual barriers to payment may suggest ways to help the NCP become more financially capable.

With NCPs in the highest earning category, aggressive collection techniques may prove quite successful. These are NCPs who have reasonable income, are expected to pay a rather small fraction of their income towards child support, and in fact have a history of meeting most payments.

The biggest problem lies with the NCPs in the two lowest earning categories who do not have barriers, who make some payments, but build up large arrears. We estimate \$225.6 million could have been at least partially collectible from these two groups. Low income, but no barriers, suggests the possibility of hidden income. Here the strategy could be to do a more extensive search for possible earning barriers, and if no barriers can be found, to pursue all possible avenues to uncover income and assets.



### **Chapter 3 References**

- 1) Peters, 2003: Jo Peters, “Determining the Composition and Collectibility of Child Support Arrearages, Volume 2: The Case Assessment,” in preparation.
- 2) Sorensen, et al., 2003: Elaine Sorensen, Heather Koball, Kate Pomper, and Chava Zibman; “Assessing the Collectibility of Child Support Arrears in California,” prepared for the Department of Child Support Services, California, December 2002.
- 3) OIG, 2002: DHHS Office of Inspector General; “Child Support for Children on TANF,” OEI-05-99-00392, February, 2002.

## Chapter 4: Neural Network Prediction Model

### Summary

*While, as shown in Chapter 2, the patterns of arrearage change are very complex, good predictions of arrearage change outcomes are possible. The neural network prediction model for child support arrearage debt is able to predict, with up to about 80 percent accuracy, the direction of change in arrearage debt for individual noncustodial parents (NCPs). The model requires NCP information from an eight quarter base period, and can make predictions for three quarters in the future or seven quarters in the future. The model shows a 127 percent increase in the number of correct predictions seven quarters in the future compared to more standard approaches.*

*The prediction system does not attempt to make predictions for all NCPs submitted, but is able to select those NCPs for whom outcomes can be more reliably predicted. It appears that for a general group of NCPs third quarter predictions will be made for about 60 percent of the individuals and up to about 75 percent of the predictions will be correct; seventh quarter predictions will be made for about 50 percent of the individuals and up to about 70 percent of the predictions will be correct. Better predictions can be made by pre-selecting individuals based on their history. For example, pre-selecting individuals with the highest earnings allowed third quarter predictions to be made for 80 percent of the individuals and 83 percent of the predictions were correct. Applications of the prediction system to newly defined NCP cohorts show promising results.*

In our earliest preliminary work we detected elements of predictability in child support arrearages. We considered 148,304 noncustodial parents from third quarter 1995 who also had records in fourth quarter 1993 and second quarter 1997, and found that 26,073 noncustodial parents whose debt increased by more than \$2,000 from 1993 to 1995 also had a debt increase of more than \$2,000 from 1995 to 1997. But there were also a significant number of debt reversals; 8,071 noncustodial parents whose debt increased by more than \$2,000 from 1993 to 1995 had a debt decrease of more than \$2,000 from 1995 to 1997, so prediction is not going to be easy. The complexity of arrearage change patterns seen in Chapter 2 also indicates the difficulty of prediction. In order to extract the maximum predictability for arrearage behavior we developed a sophisticated prediction system using neural network analysis, which is described in this chapter. Chapter 5 presents a much simpler, but less powerful, prediction system based on decision tree analysis.

Neural network modeling is used in a wide range of endeavors. It is a very flexible and adaptive modeling approach that can act to model complex systems with non-linear and non-additive elements. Our neural network prediction model allows a 127 percent increase in the number of correct predictions seven quarters in the future compared to a more standard approach such as a multinomial logit prediction model. A general discussion of the neural network approach is given in Appendix A2.

The development of the neural network prediction model used the full cohort of all identifiable NCPs in Division of Child Support (DCS) records in third quarter of calendar year 1995 (95Q3). All data was from administrative sources as detailed in Appendix A1.

Our approach was to first select a small number of data elements (variables) which appeared to have predictive power and then to develop an optimum model to obtain the best predictions. Starting with over one hundred variables, a series of tests resulted in ten variables that consistently showed predictive power. Eight predictive variables are from DCS history, one is earnings history, and one is welfare history. We show that predictability can be improved by inclusion of eight variables derived from history of use of public services and possibly three variables derived from the case studies detailed elsewhere in this report, but these variables are not included in the general models since we do not have this information for all members of the cohort, and this information would usually not be available in applications of the models. Details of the development of the neural network predictive model are given in Appendix A3.

In this chapter we describe the input information required for prediction, and the kinds of predictions which are made. We then show results for various groups of NCPs.

Strategies for using predictions will be developed incorporating information from other segments of this report in Chapter 8.

## **Model Definition**

The structure and internal parameters of the model are based on the known input information and outcomes for 5,000 randomly selected NCPs (about a 2 percent sample), and have been optimized to provide the highest number of correct predictions when applied to the entire cohort of 241,731 NCPs. The final neural network models are quite complex; details can be found in Appendix A3.

The prediction tool uses separate models for predictions three quarters in the future (Q3) and predictions seven quarters in the future (Q7). Both models require the same ten input variables from an eight quarter base period. These are defined in Table 4.1. The first five variables in Table 4.1 summarize information from the entire eight quarter base period, and the second five variables contain information only from the last quarter of the base period, what we would consider the current quarter. For most of the work described in this chapter the base period runs from 93Q4 to 95Q3, the current quarter is 95Q3, Q3 predictions are made for 96Q2, and Q7 predictions are made for 97Q2. Predictions from the models are then compared to known outcomes.

The prediction models produce the four output variables defined in Table 4.2. The output values sum to 1.00 thus each output is like a probability - corresponding to the probabilities that arrearage debt will increase (**Up**), will decrease (**Down**), will not change (**Same**), or, so that all possibilities are included, the NCP will no longer be in the child support system (**Miss**). For each individual the outcome with the highest probability is chosen as the prediction. But the prediction for an individual is accepted only if certain criteria are met indicating that the prediction is likely to be correct. This tends to maintain good accuracy, but can severely reduce the number of predictions made.

**Table 4.1: Predictive Models Base Period Input Variables**

Variable	Definition	Values
<b>DurZ</b>	# of quarters with no change in arrears	0 - 7
<b>DurN</b>	# of quarters with decreasing arrears	0 - 7
<b>DurP</b>	# of quarters with increasing arrears	0 - 7
<b>Earn</b>	Average quarterly earning	\$0 - \$XXXX
<b>Elig</b>	# of months NCP on public assistance	0 - 24
<b>TTYQ</b>	Sum of total arrearage debt in final base quarter	\$0 - \$XXXX
<b>Sbr0</b>	Not subrogated debt case in final base quarter	0 - 1
<b>Type0</b>	Case type not specified in final base quarter	0 - 1
<b>Payind</b>	Automated payment processing in final base quarter	0 - 1
<b>Iscp</b>	Custodial parent not in WA in final base quarter	0 - 1

**Table 4.2: Predictive Models Output Variables**

	PQ <sub>3</sub>	PQ <sub>7</sub>
<b>UP</b>	Debt increase \$300 or more	Debt increase \$700 or more
<b>DOWN</b>	Debt decrease \$300 or more	Debt decrease \$700 or more
<b>SAME</b>	Debt change less than \$300	Debt change less than \$700
<b>MISS</b>	Not in PQ <sub>3</sub> DCS data	Not in PQ <sub>7</sub> DCS data

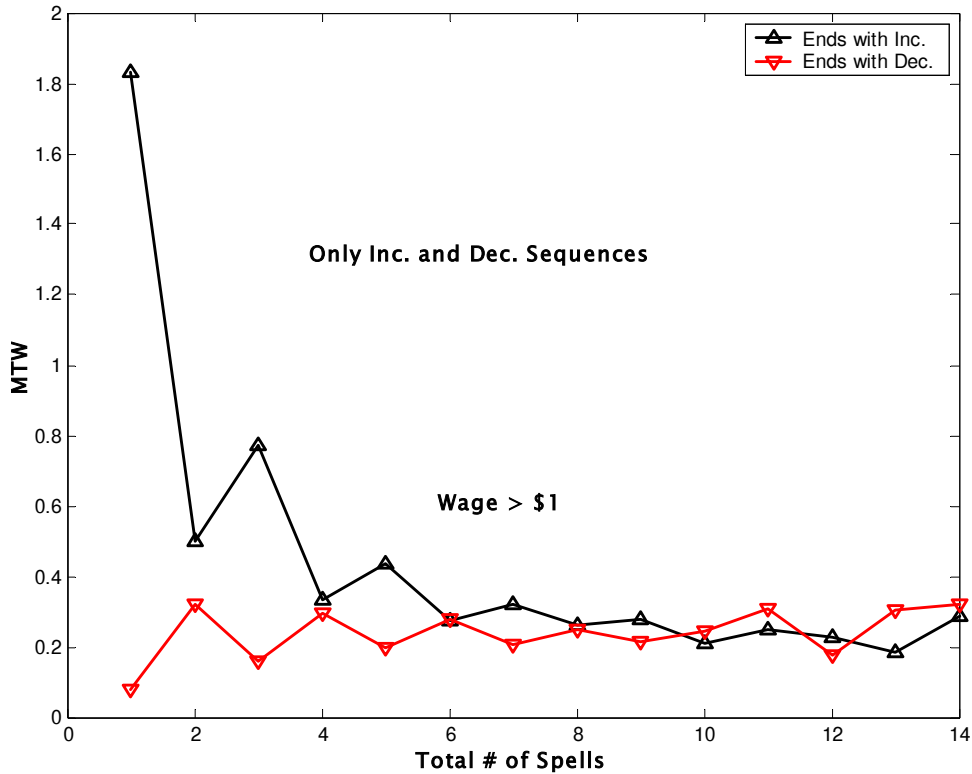
### MTW Not Useful in Prediction

Most of the development of the neural network prediction system was accomplished before the work in Chapter 3 uncovering the importance of the ratio of MOA to wage (MTW). However, it seemed necessary to ask if MTW aided predictions. We found that including MTW with the ten variables listed in Table 4.1 did not improve predictions, that is, MTW does not appear to provide additional predictive power. MTW is useful in understanding arrearage behavior for groups of NCPs over a period of time, but is not useful in predicting where the arrearage level of a particular NCP will be at a particular time.

Since cycles of increasing arrearage (*Increasing spell*) and decreasing arrearage (*Decreasing spell*) are so common (see Chapter 2) we returned to the group of NCPs examined in Figures 3.18 and 3.19, who have wages of more than \$1 per month and who have patterns with only *Increasing spells* and *Decreasing spells*. In Figure 4.1 we show the MTW related to the total number of spells, comparing those whose spell sequence ends with an *Increasing spell* to those whose spell sequence ends with a *Decreasing spell*. Except for one total spell and three total spells only small differences in MTW averages exist, so that MTW could not be

very useful to identify which sequence would end with an *Increasing spell* as opposed to a *Decreasing spell*.

**Figure 4.1: Comparing MTW for Spell Sequences Ending with an Increase or with a Decrease, for NCPs with Only Increasing and Decreasing Spells**



### Predictive Results

The results with the final predictive models applied to the entire cohort are shown in Table 4.3. The totals table segment shows there were 148,665 third quarter predictions (**fc**, 61.5 percent of the cohort) and 117,578 seventh quarter predictions (**fc**, 48.6 percent of the cohort) allowed by the prediction tool. Of the allowed predictions 74.1 percent (**fp**) were correct in Q3 and 68.7 percent (**fp**) were correct in Q7. The prediction quality for each outcome category is also presented in Table 4.3. The **Miss** outcome is the hardest to accurately predict. The percentage of correct predictions (**fp**), 53.9 percent in Q3 and 63.4 percent in Q7, is not too bad, but the percentage of actual missing NCPs identified, **fa**, is

only 7.8 percent in Q3 and 20.5 percent in Q7. Predictions for the other outcome categories are much better, with the best results shown in predicting the **Same** outcome – in Q3 75.8 percent of the predictions are correct and 88.2 percent of the NCPs in the **Same** category are correctly identified.

**Table 4.3: Testing the Optimized Models**  
*Predictions for the Entire 95Q3 Cohort*

		N	
		241,731	
		Q3	Q7
<b>MISS</b>	<b>fp</b>	53.9%	63.4%
	<b>fa</b>	7.8%	20.5%
	<b>ntp</b>	725	3,241
	<b>np</b>	1,344	5,114
	<b>na</b>	9,340	15,791
<b>UP</b>	<b>fp</b>	73.5%	66.0%
	<b>fa</b>	75.7%	78.3%
	<b>ntp</b>	36,992	28,860
	<b>np</b>	50,331	43,698
	<b>na</b>	48,873	36,876
<b>DOWN</b>	<b>fp</b>	70.0%	64.7%
	<b>fa</b>	57.3%	54.6%
	<b>ntp</b>	13,703	10,548
	<b>np</b>	19,574	16,300
	<b>na</b>	23,923	19,304
<b>SAME</b>	<b>fp</b>	75.8%	72.6%
	<b>fa</b>	88.2%	83.5%
	<b>ntp</b>	58,679	38,069
	<b>np</b>	77,416	52,466
	<b>na</b>	66,529	45,607
<b>TOTS</b>	<b>ntp</b>	110,099	80,718
	<b>np</b>	148,665	117,578
	<b>fp</b>	74.1%	68.7%
	<b>fc</b>	61.5%	48.6%

*In each outcome block ntp is the number of true predictions, np is the number of predictions allowed, na is the actual number of NCPs in each outcome category, fp is the percentage of true predictions - which is equal to ntp/np, and fa is the percentage of actual outcomes correctly identified - which is equal to ntp/na. In the totals block ntp and np are summed and fp is determined for the entire cohort; fc is the percentage of predictions allowed for the entire cohort - which is equal to total np/241,731.*

We are able to obtain even better predictions by selecting NCPs based on certain elements of their history in the base period – selections based on values of the input variables.

A prediction for 24,500 NCPs who had no change in arrearage debt in the base period (**durZ**=7; the eight quarters in the base period would lead to seven quarters of change information) gave an overall level of prediction better than for the full cohort - 81.6 percent of Q3 predictions correct, and 90.4 percent of the NCPs included in the predictions. There is a strong tendency towards predicting **Same**, and over 98 percent of NCPs who actually had no change were correctly identified in both Q3 and Q7.

A prediction for 9,624 NCPs who had continually decreasing arrears in the base period (**durN**=7) again shows an improvement in the overall level of prediction and a strong tendency for a prediction of a repeat of the base period pattern. In this sample over 99 percent of NCPs who actually had a decrease in debt were correctly identified in both Q3 and Q7.

A prediction for 29,127 NCPs who had continually increasing arrears in the base period (**durP**=7) again shows an improvement in the overall level of prediction and a strong tendency for a prediction of a repeat of the base period pattern. In this sample over 99 percent of NCPs who actually had an increase in debt were correctly identified in both Q3 and Q7.

In the above three examples, selecting on extreme durations, simple prediction procedures would rival the neural network predictions for accuracy. Simply predicting for Q3 that the previous arrearage trend continues would lead to 81.7 percent correct predictions for those with **durZ**=7, to 68.9 percent correct predictions for those with **durN**=7, and to 77.8 percent correct predictions for those with **durP**=7. But it would be much more difficult to make accurate simple predictions for NCPs with high quarterly earnings. We show in Table 4.4 the detailed predictions for 21,514 NCPs whose average quarterly earnings were \$7,355 or more during the base period. The overall accuracy of prediction is 83.3 percent and 78.0 percent in Q3 and Q7 respectively. We are able to make predictions for 79.9 percent of the NCPs in Q3 and 72.6 percent of the NCPs in Q7. There is a strong tendency towards predicting **Down** or **Same**, with well over 90 percent of NCPs actually in those categories correctly identified in both Q3 and Q7. A simple prediction might have predicted **Down** or **Same** but would have been unable to properly place NCPs in those categories. The important point is that with the neural network prediction tool highly accurate predictions can be made for groups of NCPs where simple prediction procedures will not work.



**Table 4.4: Selected Testing of the Optimized Models**  
**Predictions for 21,514 NCPs with "Earn" \$7,355 or More**

		21,514	
		Q3	Q7
<b>MISS</b>	<b>fp</b>	62.0%	70.6%
	<b>fa</b>	8.6%	10.2%
	<b>ntp</b>	75	233
	<b>np</b>	121	330
	<b>na</b>	871	2,294
<b>UP</b>	<b>fp</b>	59.7%	37.1%
	<b>fa</b>	4.6%	8.3%
	<b>ntp</b>	74	92
	<b>np</b>	124	248
	<b>na</b>	1,604	1,114
<b>DOWN</b>	<b>fp</b>	76.3%	72.5%
	<b>fa</b>	94.5%	94.3%
	<b>ntp</b>	2,591	1,666
	<b>np</b>	3,396	2,298
	<b>na</b>	2,741	1,767
<b>SAME</b>	<b>fp</b>	85.5%	80.0%
	<b>fa</b>	96.7%	97.6%
	<b>ntp</b>	11,591	10,200
	<b>np</b>	13,557	12,751
	<b>na</b>	11,982	10,452
<b>TOTS</b>	<b>ntp</b>	14,331	12,191
	<b>np</b>	17,198	15,627
	<b>fp</b>	83.3%	78.0%
	<b>fc</b>	79.9%	72.6%

see Table 4.3 footnote for definitions

It is also true that certain selected groups of NCPs will generate very poor predictions. If we select NCPs who were in DCS records only in the final quarter (95Q3) of the base period their arrearage change durations would show them missing (**durM**=7) for seven quarters. The predictions for this group have a low accuracy (Q3 **fp** = 57.8 percent) and a particularly low percentage of the cohort (Q3 **fc** = 4.7 percent) where a prediction was allowed. The arrearage history measured by **durZ**, **durN**, and **durP** is critical information in making good predictions. For NCPs with high **durM** there is simply not enough known about arrearage history. But even in these situations the prediction tool attempts to maintain accuracy by selecting predictions more likely to be correct.

Table 4.5 shows results for various groups used in this study with corresponding values of the percentage of the group with  $durM \geq 5$ . Groups not previously discussed will be defined in subsequent sections. Using only the five groups selected from the 95Q3 cohort Figure 4.2 shows a fairly linear relationship between the percentage with high  $durM$  and prediction quality ( $fp$  and  $fc$ ). As the proportion of NCPs with  $durM \geq 5$  grows the accuracy of prediction drops and the percentage of possible predictions dramatically decreases.

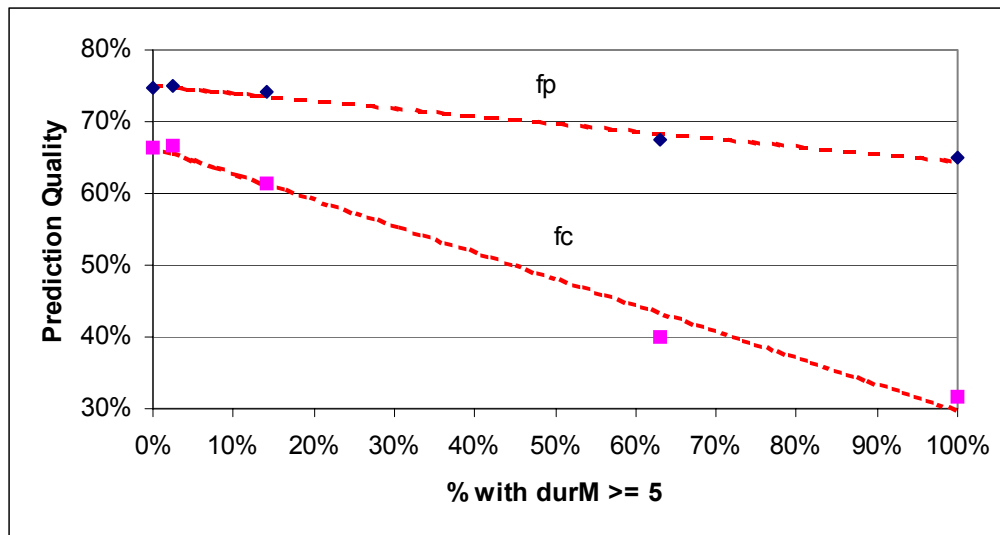
**Table 4.5: Prediction Results and Base Period  $durM$**

Group	N	High $durM^*$	Tot fp Q3	Tot fc Q3
95Q3 cohort	241,731	14.1%	74.1%	61.5%
95Q3 x- matched	195,401	2.5%	75.0%	66.6%
95Q3 not x- matched	46,330	63.1%	67.6%	39.9%
96Q4 cohort	203,234	0.1%	71.4%	64.4%
97Q1 cohort	198,699	0.1%	72.6%	65.3%
97Q2 cohort	193,226	0.2%	73.1%	66.0%
98Q4 cohort	89,481	29.4%	65.4%	62.8%
95Q3 high $durM$	34,178	100.0%	64.9%	31.7%
95Q3 low $durM$	207,553	0.0%	74.8%	66.4%

\* percentage with  $durM \geq 5$

**Figure 4.2: Prediction Quality Depends on High  $durM$**

*All Groups from 95Q3 Cohort*



## **Applying the Predictive Model**

We first applied the neural network prediction tool using 96Q4, 97Q1, or 97Q2 as the “current” quarter. The base period for each of these applications was the “current” quarter plus the preceding seven quarters. New outcome data was obtained so that predictions could be compared with actual outcomes. Because we do not have complete earnings information, except for NCPs in our original 95Q3 cohort, we used the prediction tool with 203,234 NCPs still active in 96Q4, 198,699 NCPs still active in 97Q1, and 193,226 NCPs still active in 97Q2. These are all individuals who were part of the 95Q3 cohort, and a high level of accuracy in prediction is seen. Q3 predictions had **fp**=71.4 percent and **fc**=64.4 percent for the 96Q4 group, **fp**=72.6 percent and **fc**=65.3 percent for the 97Q1 group, and **fp**=73.1 percent and **fc**=66.0 percent for the 97Q2 group. Probably the good results are partly due to the very low level of NCPs who have missing quarters of data in the base period (see Table 4.5 and accompanying discussion above). By selecting NCPs from the 95Q3 cohort who are still active in subsequent quarters, NCPs with extensive missing DCS data in the base period have largely been eliminated.

Finally we attempted a prediction for a new group of individuals – all NCPs in 98Q4 DCS records who were *not* in the 95Q3 cohort. This is a cohort of 89,481 NCPs completely new to the neural network prediction, and selected in a time frame very different from 95Q3. The entire development of the neural network prediction model was intentionally done with information before the implementation of welfare reform. We are now applying the developed model to a group selected about a year after the implementation of welfare reform, and under economic conditions very different from the eight quarter base period on which the prediction model is based. In addition, we do not have earnings history for most of these individuals. Because 22,443 of these NCPs do have a history of welfare use, we do have access to earnings records for these individuals. For the 67,038 individuals without earnings data, we substituted a mean value (because the network uses transformed inputs – see Appendix A3 - where the mean is 0, this is easy to do). A further difficulty exists because this selection of NCPs predisposes the cohort towards NCPs new to DCS, with 29.4 percent showing extensive missing quarters of DCS data in the base period (see Table 4.5 and accompanying discussion above). Table 4.6 shows these results, which are outstandingly good given the difficulty of this prediction. Q3 predictions were allowed for 62.8 percent of the cohort (**fc**) and 65.4 percent of the predictions were correct (**fp**).

**Table 4.6: Applying the Optimized Models**  
**Predictions for 89,481 NCPs in 98Q4 and not in 95Q3**

N		89,481	
		Q3	Q7
<b>MISS</b>	<b>fp</b>	40.5%	52.7%
	<b>fa</b>	14.4%	30.9%
	<b>ntp</b>	633	1,473
	<b>np</b>	1,563	2,795
	<b>na</b>	4,392	4,765
<b>UP</b>	<b>fp</b>	59.9%	52.7%
	<b>fa</b>	60.4%	73.4%
	<b>ntp</b>	10,783	7,230
	<b>np</b>	17,987	13,713
	<b>na</b>	17,858	9,851
<b>DOWN</b>	<b>fp</b>	64.9%	55.7%
	<b>fa</b>	36.2%	46.9%
	<b>ntp</b>	2,602	3,119
	<b>np</b>	4,010	5,598
	<b>na</b>	7,181	6,644
<b>SAME</b>	<b>fp</b>	69.6%	77.7%
	<b>fa</b>	84.9%	72.6%
	<b>ntp</b>	22,699	9,437
	<b>np</b>	32,600	12,150
	<b>na</b>	26,729	12,996
<b>TOTS</b>	<b>ntp</b>	36,717	21,259
	<b>np</b>	56,160	34,256
	<b>fp</b>	65.4%	62.1%
	<b>fc</b>	62.8%	38.3%

see Table 4.3 footnote for definitions

**Incorporating Inputs from Cross-Program Use and Case-Level Analysis**

Prediction quality appears to be slightly improved by inclusion of additional base period information. For 195,401 NCPs in the 95Q3 cohort we have information on program and service use in five divisions of the Department of Social and Health Services (DSHS) for State Fiscal Year 1994 (SFY94; calendar quarters 93Q3, 93Q4, 94Q1, and 94Q2). This covers 159 specific services or programs, but we aggregated this information to limit the number of variables. Testing, as described in Appendix A3, gave us eight additional variables (see Table 4.7) which appeared to improve the predictive power of the ten input variables defined in Table 4.1.

**Table 4.7: Cross-Program Input Variables**

<b>Variable</b>	<b>Definition</b>	<b>Values</b>
<b>Pgm30</b>	DASA pgm: ADATSA Dual/Diff Diag Resid Tx	0 - 1
<b>Pgm31</b>	DASA pgm: ADATSA Long Term Residential Tx	0 - 1
<b>Pgm55</b>	ESA pgm: AFDC/JOBS Child Care Employed	0 - 1
<b>Pgm85</b>	MAA pgm: ER-Other Physician Services	0 - 1
<b>Pgm140</b>	MHD pgm: Individual Medication Management	0 - 1
<b>Fpat18*</b>	MAA pgm: ER-Hospital Outpatient Other	0 - 1
	MAA pgm: Psychiatric-Outpatient Hospital	
	MAA pgm: Other Outpatient Hospital	
<b>Opat35**</b>	ESA pgm: JOBS On-the-Job-Training-DSHS	0 - 1
	MAA pgm: Indian Health Care Center	
	DVR pgm: Long-Term SE Followup	
<b>MHDpgms</b>	# of programs from Mental Health Division	0 - 28

*\* Functional pattern - programs grouped within Division by similarity of function*

*\*\* Outcome pattern - programs grouped across Divisions by similarity of effects on outcomes*

At present cross-program variables are not included in our general predictive models. Most importantly this information is not available for other time frames. Even in the present work the time frame for cross-program use is not optimum for our predictive models. It would be best to have this information spanning the entire eight quarter base period, or at least to have the data span the final four quarters of the base period (94Q4, 95Q1, 95Q2, and 95Q3 for the 95Q3 cohort). We would expect that data more current to the prediction would contain more useful predictive information.

Secondly, there are indications that the 46,330 NCPs without cross-program data are different from the 195,401 NCPs with cross-program data. The 46,330 NCPs were missed in the cross-program match because they were not in DCS records in SFY94. Thus they are NCPs with more quarters of missing data in the base period, and as Table 4.5 shows, outcomes can be predicted less accurately for a lower percentage of NCPs than the 195,401 NCPs with cross-program data.

We present a preliminary comparison of eighteen variable (**V18**) input prediction models, and compare results to the ten variable (**V10**) input models described above. The **V18** models are not as fully optimized as the **V10** models, so this is not an entirely fair comparison.

Table 4.8 shows results, where it can be seen that the accuracy of Q3 prediction – **fp** – is essentially the same for **V10** and **V18**, but the total number of NCPs

correctly predicted (**ntp**) is almost 5,000 larger for **V18** in Q3. Given that the **V18** model is not fully optimized, this is a good indication that cross-program information could improve prediction quality, particularly with information current to the prediction. Information on use of public services or programs can indicate possible barriers to payment, and can also indicate treatments to overcome barriers.

**Table 4.8: Including Cross-Program Inputs**

N		195,401	195,401
		V10	V18
		Q3	Q3
<b>MISS</b>	fp	57.3%	66.9%
	fa	11.6%	3.1%
	ntp	718	238
	np	1,252	356
	na	6,211	7,727
<b>UP</b>	fp	75.0%	74.4%
	fa	77.3%	74.7%
	ntp	32,038	31,406
	np	42,726	42,219
	na	41,445	42,039
<b>DOWN</b>	fp	71.9%	69.0%
	fa	54.1%	63.0%
	ntp	12,054	14,298
	np	16,760	20,722
	na	22,285	22,688
<b>SAME</b>	fp	75.2%	75.5%
	fa	88.2%	87.4%
	ntp	47,063	50,627
	np	62,556	67,051
	na	53,353	57,893
<b>TOTS</b>	ntp	91,873	96,569
	np	123,294	130,347
	fp	74.5%	74.1%
	fc	63.1%	66.7%

see Table 4.3 footnote for definitions

We also tested 32 variables derived from the case-level analysis for possible predictive power by the methods described in Appendix A3. Three variables - **basA**, **bas2D**, and **subrcod** - showed a possible enhancement in the number of correct predictions. See Table A3.1 for a definition of these variables. However, because this test could only be conducted with those selected for case-level analysis, the number of NCPs is too small for this to be considered a reliable result.



## Chapter 5: Decision Tree Prediction Model

### Summary

*The decision tree model is a second, and much simpler, approach to using predictability. From a general group of noncustodial parents (NCPs) the decision tree model is able to select a 10 percent sub-group of individuals who have about an 80 percent probability of increased arrearage three quarters in the future, and a different 10 percent sub-group who have about an 8 percent probability of increased arrearage three quarters in the future.*

We have developed a second prediction model for child support arrearage debt using inductive decision tree modeling. While the neural network model is powerful, it is computationally intensive and difficult to understand. The final decision tree model requires no computation, is easy to understand, and could be useful for making quick predictions. Decision trees are familiar constructs, often implemented in a 'if....then' question series which allows selection of sub-groups strongly enriched (or depleted) in a particular outcome.

In developing the decision tree model the same data was used as in developing the neural network model. Our previous work on the neural network model identified the ten input variables defined in Table 4.1 as useful predictors of arrearage behavior as encapsulated by the four outcome variables defined in Table 4.2. The basic approach in this chapter is to use input variable data to select sub-groups and to measure the power of the selection using the known outcome data.

### Decision Tree Framework

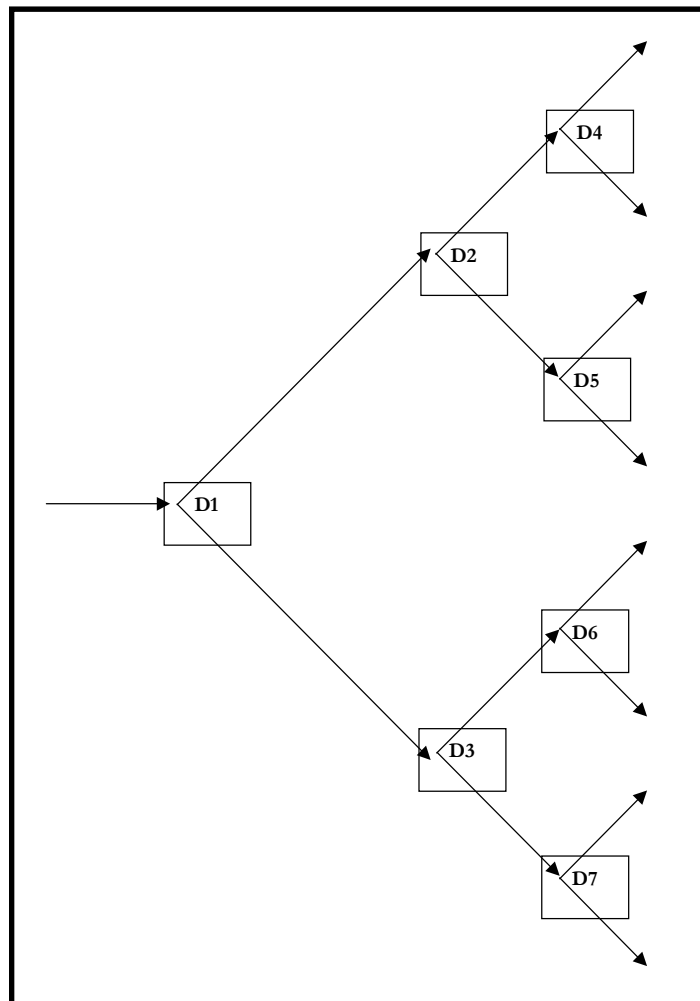
To limit the enormous number of possible decision trees we have chosen to convert all numerical variables to dichotomous indicators, and to only pursue decision trees with three levels - this means that each individual will be queried at three decision points, and at the end of the decision process individuals will have been sorted into eight sub-groups. We have experimented with expanding the numerical variable conversion to four levels, which produced a richer variety of decision trees but did not appear to improve predictability. We also experi-



mented with taking each arrearage outcome separately, or treating them together as we do in the neural network prediction model. A separate decision tree for each outcome gave better predictability. We limit ourselves to models predicting the outcomes **Up**, **Down**, and **Same**; it does not appear possible to accurately predict the outcome **Miss**.

The basic decision tree framework used is shown in Figure 5.1. Individuals are hierarchically classified by entering from the left and leaving on the right, with their path through the system determined by the seven decision points labeled D1 through D7. There are eight exit groups and our aim is to design decision points such that some of the exit groups are strongly enriched, or strongly depleted, in the outcome of interest. The decision paths leading to those exits can then be used in prediction.

**Figure 5.1: Basic Decision Tree Framework**



See Appendix A4 for details on the selection of queries at decision points. Table 5.1 shows our best results for Q3 predictions. We have chosen decision pathways which lead to the best discrimination, compromising the number of individuals who fall into the predicted categories. As Table 5.1 shows, three of the prediction categories have about 80 percent probability of being correct, and one of the categories is over 90 percent probable. Table 5.1 also summarizes the decision tree pathways as decision rules. For example, if **durP** is less than or equal to three quarters, then if **Type0**=1, then if **PayInd**=1, then there is a 92.3 percent probability that Q3 arrears will be less than \$300 higher than current arrears. Once a set of decision rules has been determined they could in principle be used in any order, but in practice it is best to remember that these are hierarchical rules. For the **Not Up** outcome, for example, it has been determined that **durP** is the best variable with which to query all input individuals. If **durP** is unknown there may be no point in trying to make a prediction, while reasonable predictions may be possible if **PayInd** is not known.

**Table 5.1: Decision Tree Rules and Results for Q3 Predictions**

outcome	1 <sup>st</sup> Level	2 <sup>nd</sup> Level	3 <sup>rd</sup> Level	% of Cohort	% w outcome
<b>Not Up</b>	durP ≤ 3Q	Type0 1	PayInd 1	10.5%	92.3%
<b>Up</b>	durP >6Q	T95Q3 >\$4107	PayInd 1	10.0%	80.4%
<b>Down</b>	T95Q3 >\$262	durN >6Q	Elig ≤ 2mo	3.4%	76.2%
<b>Same</b>	T95Q3 ≤ \$340	PayInd 1	Type0 0	21.0%	80.5%

Using the decision rules from Table 5.1 on the 98Q4 cohort introduced in Chapter 4, we find that an 11.4 percent sub-group was predicted **Not Up** and 83.1 percent of these predictions were correct, and a 4.0 percent sub-group was predicted **Up** and 77.9 percent of these predictions are correct. This is a very good result considering the difficulties of this prediction. See Chapter 4 for further information on the 98Q4 cohort.



## Chapter 6: Effects of Prediction Input Variables

### Summary

*We view overall averages to gain some understanding of the effects of each prediction input variable on arrearage change outcomes. But this, at best, only applies to large groups of individuals. With small groups of individuals the effects of a particular input variable may depend on several other input variables. This does, however, give us a general view of the effects of several important measures related to arrearage.*

In designing a neural network prediction model for individuals we sacrifice to a large extent our understanding of the effects of each input variable. The final internal parameters of the network will have virtually no meaning; two networks which give equally good results can have vastly different sets of parameters. And, since the network incorporates non-linear and non-additive responses, it is not reliable to try to determine effects by substituting values for input variables. The effect of a given variable can depend strongly on the values of several other variables. This does suggest that models which do not account for non-linearity and non-additivity in systems where it exists can give very misleading impressions of the effects of certain variables.

While the effects of each variable may too complex to fully understand, we attempt to obtain some idea of variable effects through viewing overall averages. This must be used with caution, but if we restrict consideration to large groups of NCPs, the effects of other variables may tend to ‘wash out,’ and we may be able see the general effects of the variable of interest. We limit this inquiry to only the ten variables listed in Table 4.1.

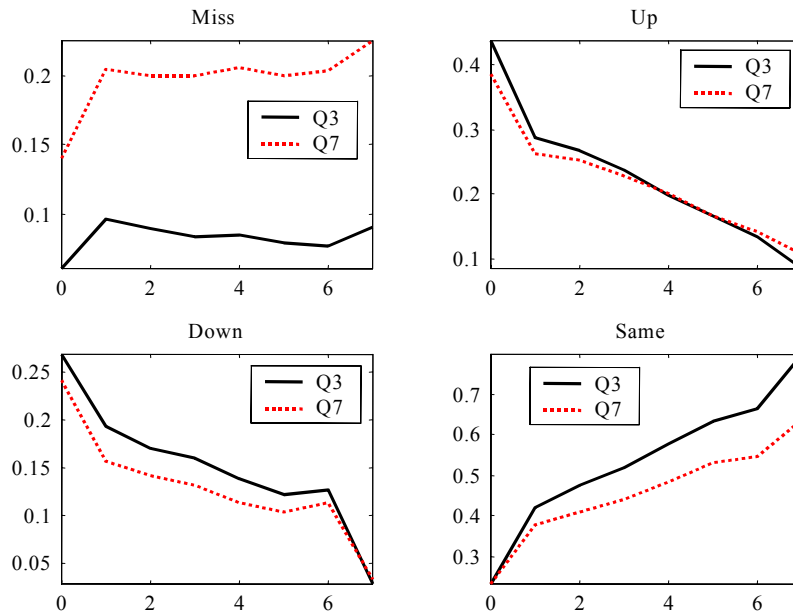
### Effects of the Spell Duration Variables

There are eight possible values for the duration variables (0 - 7 quarters). Figures 6.1, 6.2, and 6.3 show the average outcomes for each level of **durZ**, **durN**, and **durP** respectively (see Table 4.1 for definition of variables and Table 4.2 for definition of outcomes).

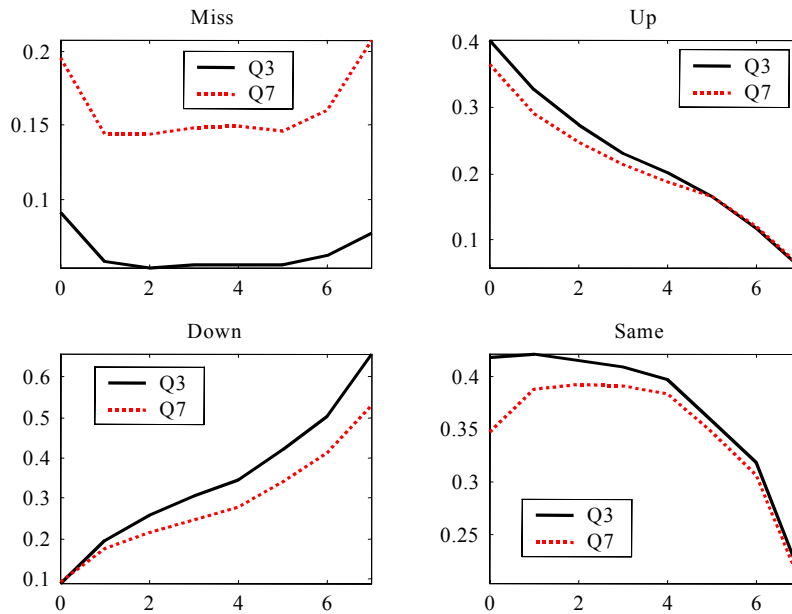
In general, with the exception of the **Miss** outcome, as a particular duration variable increases in value, the outcome it resembles becomes more likely and other outcomes become less likely. However, there is a hump in the Q7 **Same**

outcome as **durN** increases (Figure 6.2), and marked humps in both Q3 and Q7 **Down** outcome as **durP** increases (Figure 6.3). This suggests that a short spell of increasing arrearage in the base period is more likely to produce a **Down** outcome than no spell (**durP=0**) of increasing arrearage in the base period. This appears counter-intuitive, but is in fact in agreement with the finding reported in Table 2.6 - a spell of increasing arrearage is most commonly terminated by a spell of decreasing arrearage.

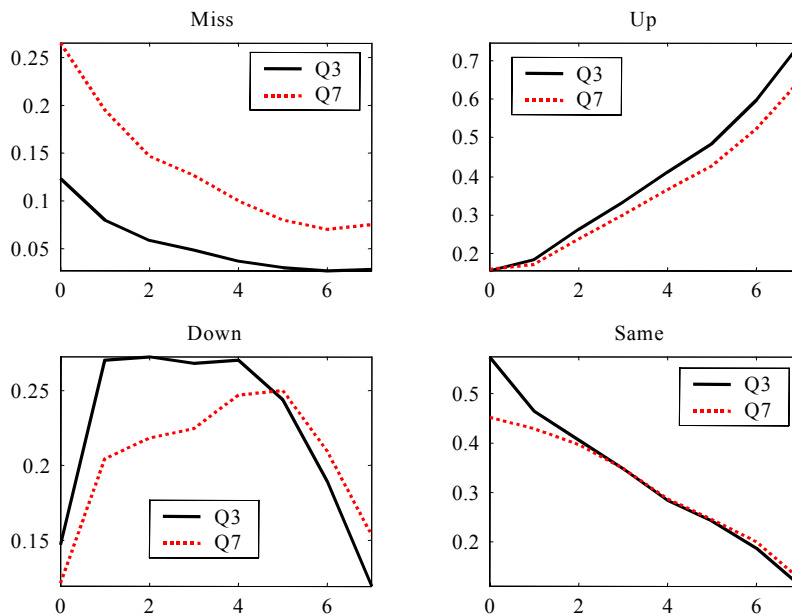
**Figure 6.1: Effects of "durZ" on 95Q3 Outcomes**  
**Horizontal Axis: Quarters of No Arrearage Change**  
**Vertical Axis: Average Outcome Value**



**Figure 6.2: Effects of "durN" on 95Q3 Outcomes**  
**Horizontal Axis: Quarters of Decreasing Arrearage**  
**Vertical Axis: Average Outcome Value**

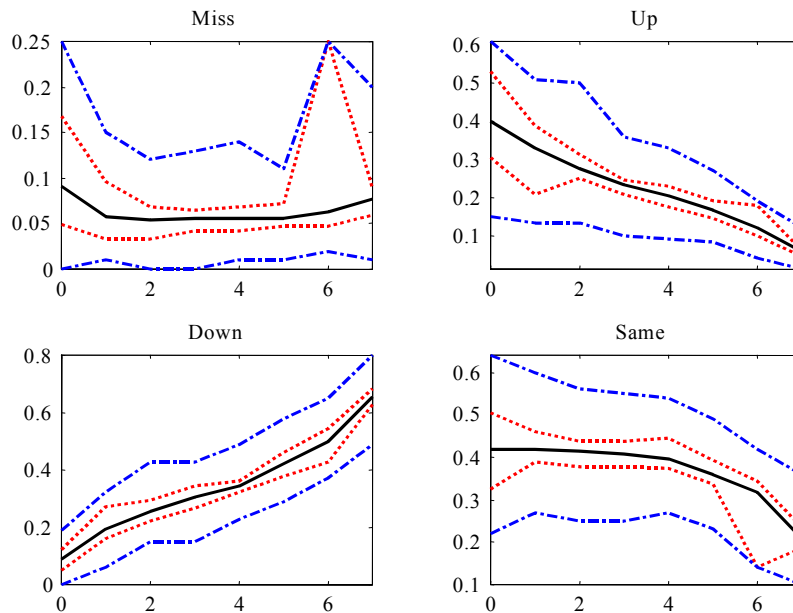


**Figure 6.3: Effects of "durP" on Outcomes**  
**Horizontal Axis: Quarters of Increasing Arrearage**  
**Vertical Axis: Average Outcome Value**



We estimate variability by sub-grouping by 1,000 NCPs or 100 NCPs at each level of the spell history variables. An example is shown in Figure 6.4 for **durN**. In this Figure the solid line shows the average outcome for the entire group at each level. The dotted lines are the maximum and minimum average outcomes for randomly selected sub-groups of 1,000, and the dash-dot lines are the maximum and minimum average outcomes for randomly selected sub-groups of 100. This shows clearly that as we reduce the number of NCPs we are considering, variable effects become more obscure. This occurs for all the variable effects shown in this chapter, but to conserve space is only shown in this example.

**Figure 6.4: Variability of "durN" Effects on Q3 Outcomes**  
*Horizontal Axis: Quarters of Decreasing Arrearage*  
*Vertical Axis: Average Outcome Value*



*black solid line is average outcome at each **durN** value;*  
*red dotted lines are maximum and minimum average*  
*outcomes for randomly selected sub-groups of 1000;*  
*blue dash-dot lines are maximum and minimum average*  
*outcomes for randomly selected sub-groups of 100*

## Effects of Indicator Variables

There are noticeable differences in outcomes between the “0” and “1” categories for all the indicator variables (see Table 4.1 for definition of variables). Figure 6.5 shows the different levels of associated outcomes.

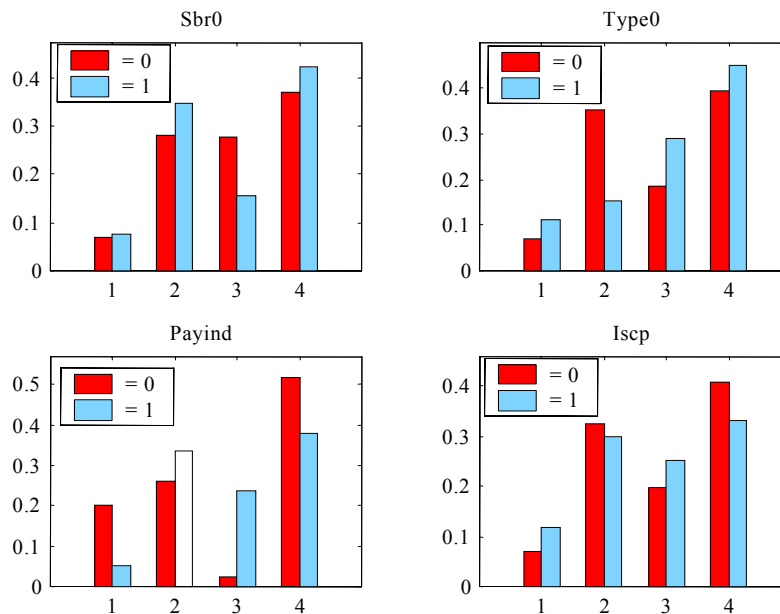
When **Sbr0**=1 a non-subrogated debt is indicated and Figure 6.5 suggests that the outcomes **Up** and **Same** will be more likely and the **Down** outcome will be less likely.

When **Type0**=1 the case type is not specified and Figure 6.5 suggests that the outcomes **Miss**, **Down**, and **Same** will be more likely and the **Up** outcome will be less likely.

When **Payind**=1 automated payment processing is in effect and Figure 6.5 suggests that the outcomes **Up** and **Down** will be more likely and the outcomes **Miss** and **Same** less likely.

When **Iscp**=1 the custodial parent is not in Washington and Figure 6.5 suggests that the outcomes **Miss** and **Down** will be more likely and the outcomes **Up** and **Same** less likely.

**Figure 6.5: Effects of Indicator Variables on Q3 Outcomes**  
**Horizontal Axis: 1 = Miss, 2 = Up, 3 = Down, 4 = Same**  
**Vertical Axis: Average Outcome Value**

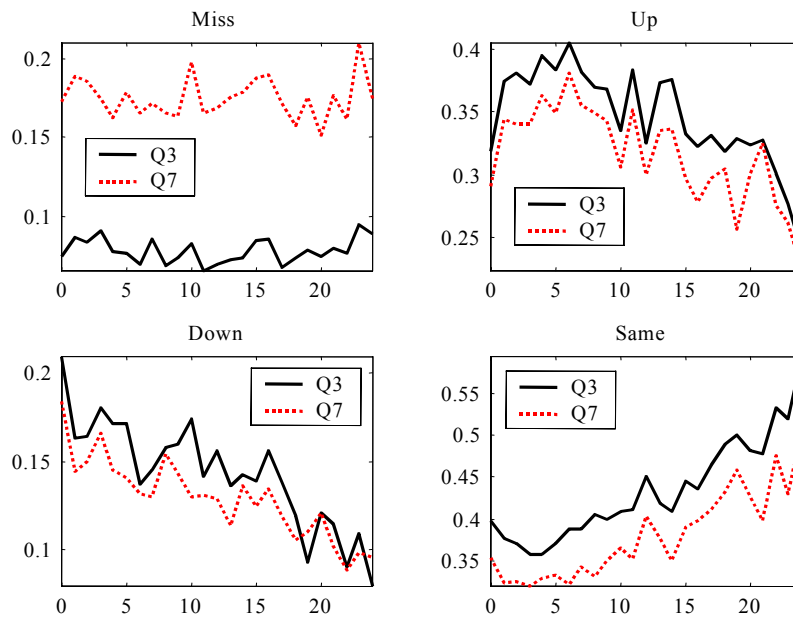




## The Effects of "Elig"

The values of **Elig** (see Table 4.1 for definition of variables) range from 0 to 24 months but the number of NCPs in each level from 9 to 23 is less than 1000. Figure 6.6 shows that as **Elig** increases the outcomes **Up** and **Down** occur less frequently while the outcome **Same** occurs more frequently.

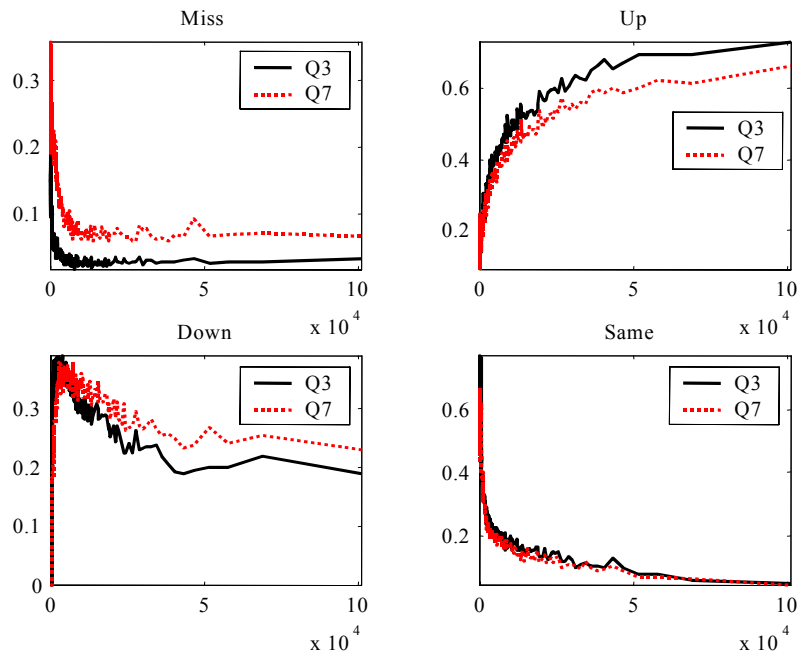
**Figure 6.6: Effects of "Elig" on Outcomes**  
**Horizontal Axis: Months of Welfare Use**  
**Vertical Axis: Average Outcome Value**



## The Effects of Continuous Variables

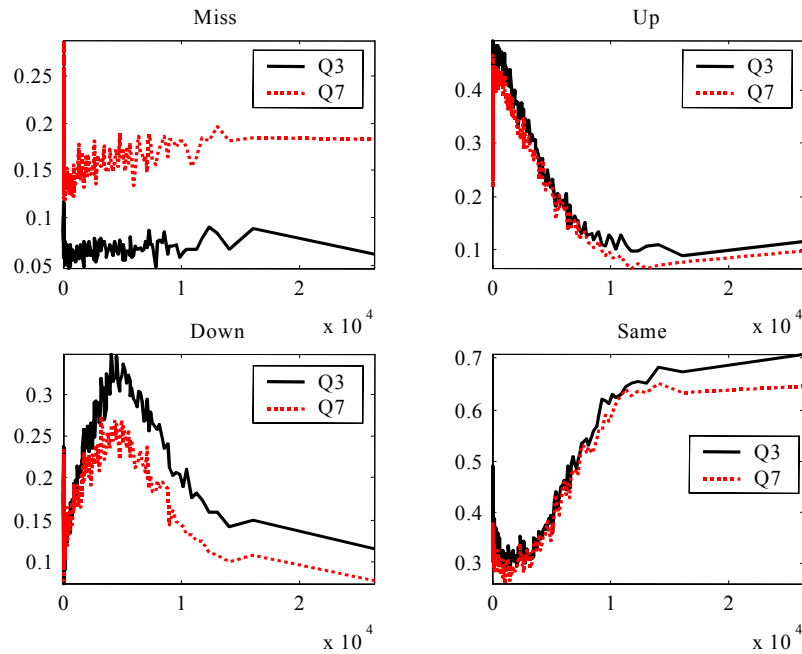
Values for **T95Q3** (see Table 4.1 for definition of variables) for individual NCPs range from \$0 to \$790,391, with 79.1 percent of the NCPs having a debt of \$10,000 or less. NCPs were placed in ascending order of **T95Q3** and averages were taken for groups of 1000 NCPs for the charts in Figure 6.7. As **T95Q3** increases the outcome **Up** occurs more frequently, the outcomes **Miss** and **Same** drop dramatically in frequency, and the outcome **Down** drops but remains relatively common.

**Figure 6.7: Effects of "T95Q3" on Outcomes**  
**Horizontal Axis: Arrearage in 95Q3**  
**Vertical Axis: Average Outcome Value**



Average quarterly earnings for individual NCPs, **Earn** (see Table 4.1 for definition of variables), ranged from \$0 to \$930,470 with 96.1 percent of the NCPs earning \$10,000 or less per quarter. NCPs were placed in ascending order of **Earn** and averages were taken for groups of 1000 NCPs for the charts in Figure 6.8.

**Figure 6.8: Effects of "Earn" on Outcomes**  
**Horizontal Axis: Average Earning**  
**Vertical Axis: Average Outcome Value**



The outcomes **Up**, **Down**, and **Same** show a complex relation to earnings, but these charts do relate to results presented in Chapter 3, particularly Figure 3.9. At lower earnings child support obligations appear to be generally set above the level where arrears do not grow, thus the **Up** outcome could be expected to occur more frequently. At higher earnings child support obligations appear to be generally set below the NCP's ability to pay and many NCPs do not owe arrears and thus cannot decrease arrears, leading to a decrease in the frequency of the **Down** outcome.

## Chapter 7: Arrearage and Custodial Parent Work and Welfare Outcomes

### Summary

*Past work has shown that custodial parents who receive regular child support payments have more favorable work and welfare outcomes. In this chapter the arrearage characteristics of the noncustodial parent are linked to subsequent custodial parent welfare use and custodial parent employment.*

*For custodial parents classified with regular child support payments the associated noncustodial parent is expected to pay a significantly lower percentage of monthly income, providing some explanation for regularity of payment. Additionally, noncustodial parents whose child support obligations are 20 percent or less of monthly earnings are over three times more likely to be associated with custodial parents classified with regular payments.*

Past research in Washington State, covering late 1993 to mid-1997, has examined the cost avoidance impacts of child support collections. It has been shown that custodial parents classified as receiving regular child support payments subsequently use less welfare and have more employment. This effect occurs after welfare exit through a lower recidivism rate and both a higher rate of finding work and a lower rate of job loss. While on welfare custodial parents with regular payments appeared identical to custodial parents with irregular payments in terms of rate of welfare exit and in terms of rates of finding and losing work (Formoso; 1999, 2000, & 2002).

However, since we did not have access to historical payment records, the classification into regular payment required that monthly order amount (MOA) be greater than \$0 and that the total arrearage level be less than twice the MOA. It was found that when custodial parents changed payment classifications from quarter to quarter the factor responsible for the switch in about 80 percent of cases was a change in arrearage debt. This creates a link between the cost avoidance work and the present study on arrearage.

## Arrearage and Cost Avoidance

The cost avoidance study to date has used three separate cohorts with follow-up periods of thirteen quarters or five quarters. In the present work we use the previously studied cohort of all welfare clients in 95Q4 with five follow-up quarters. Welfare clients who were also CPs in 95Q4 DCS records were linked to their associated NCPs in the arrears study.

Incorporating the overall view of arrearage growth presented in Chapter 3, Table 7.1 shows the 15 quarter averages for MOA, monthly wages, arrearage debt change, and the MTW (MOA to Wage ratio, measuring the burden of support obligations) and ATM (Arrears change to MOA ratio, estimating the number of missed payments) calculated from these averages for NCPs linked to custodial parents classified with regular payments and NCPs linked to custodial parents classified with irregular payments.

**Table 7.1: Characteristics of NCPs Aggregated by CP Classification**

	m	w	d	MTW	ATM	N
Reg Pmt.	\$220	\$1,136	\$308	0.19	1.40	7,137
Irreg Pmt.	\$198	\$423	\$5,431	0.47	27.42	75,624

*m is average MOA, w is average monthly wages, d is average arrears change, MTW=m/w, ATM=d/m, and N is the number of CPs in each category; all differences are statistically significant (p <0.0001)*

We see that CPs who have regular payments, which in turn are linked to favorable work and welfare outcomes, are associated with NCPs who are, on average, expected to pay 19 percent of their monthly wage, while CPs who have irregular payments are associated with NCPs who are, on average, expected to pay 47 percent of their monthly wage. It is reasonable that when noncustodial parent child support obligations are a smaller percentage of earnings regular payments would be more likely, but in addition the lower percentage obligation is associated with more favorable custodial family outcomes.

We then restrict consideration to 55,133 NCPs whose average monthly earnings is more than \$1 per month and calculate MTW on an individual basis (see Chapter 3). There are several indications presented in Chapter 3 which suggest that a MTW over 20 percent begins to cause problems with arrearage debt growth. Creating two NCP groups in Table 7.2 shows that those with MTW of 20 percent or less are over three times more likely to have the associated CPs classified with regular payments. On average those with MTW 20 percent or less are expected to pay 9 percent of their earnings and have missed only one payment,

while those with MTW greater than 20 percent are expected to pay 71 percent of earnings and have missed 29 payments.

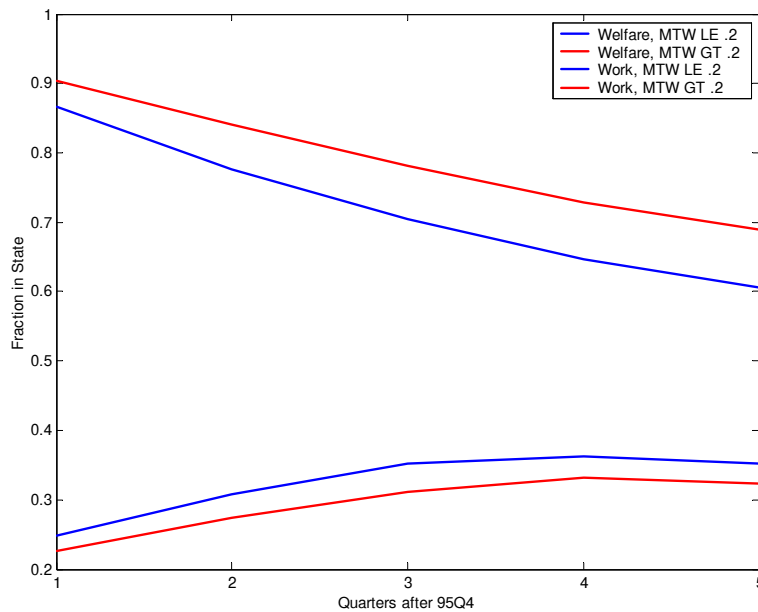
**Table 7.2: CP Classification Aggregated by NCP MTW Level**

	Reg Pmt.	MTW	ATM	N
MTW LE .2	0.17	0.09	1.23	22,430
MTW GT .2	0.05	0.71	29.31	32,703

*In the first column LE means “less than or equal to” and GT means “greater than,” with MTW calculated on an individual basis for classification. In the second column Reg Pmt. is the fraction of CPs in the regular payment category. MTW and ATM are as in Table 7.1, and N is the number of NCPs. All differences are statistically significant ( $p < 0.0001$ )*

We further show that indeed better CP outcomes are linked to NCPs with a MOA set at 20 percent or less of monthly earning. Figure 7.1 summarizes the average outcomes over five follow-up quarters for the two groups presented in Table 7.2. Throughout the follow up period CPs associated with NCPs having MTW 20 percent or less show a higher level of work and a lower level of welfare.

**Figure 7.1: CP Outcomes Aggregated by NCP MTW Level**



While these are average outcomes, and not controlled for other factors which may affect outcomes, Figure 7.1 is a good indication that how MOA is set relative to earnings has ramifications beyond arrearage debt growth. It is a clear indication that setting MOA too high relative to earnings will, on average, do little to benefit custodial parents, or the children that ultimately should benefit from the child support system.

## **Chapter 7 References**

- 1) Formoso, 2002: Carl Formoso; "Child Support Enforcement: Net Impacts on Work & Welfare Outcomes & the Utility of Cross-Program Information," May, 2002
- 2) Formoso, 2000: Carl Formoso; "Child Support Enforcement: Net Impacts on Work & Welfare Outcomes pre- & post-PRWORA," August, 2000
- 3) Formoso, 1999: Carl Formoso; "The Effect of Child Support and Self-Sufficiency Programs on Reducing Direct Support Public Costs," May, 1999.

*These papers are available in pdf format from*

<http://www.dshs.wa.gov/dcs/reports.shtml>

## **Chapter 8: Conclusions**

The bulk of arrearage growth during the fifteen quarters examined in this study was accrued by noncustodial parents whose gross monthly earnings were \$1,400 or less. As earnings decrease below \$1,400 the burden of child support obligation as a percent of earnings rises steeply. And as earnings decrease noncustodial parents have more documented barriers to earning adequate income and paying ordered child support. These factors appear to drive much of the character and the outcomes of noncustodial parent arrearage behavior.

The main conclusion from findings presented in Chapter 3 is that low earning noncustodial parents are on average simply not able to pay the ordered level of child support. For low earners when obligation is set too high relative to earnings collections are going to be difficult, if at all possible. On the other hand, the results in Chapter 3 show that for noncustodial parents with monthly earnings above \$1,400 an increase in obligation may lead to additional collections. This was not further investigated in this study because it is not an arrearage problem.

The dynamic composition of arrearage debt is quite complex. There are over 6,400 patterns of arrearage change behavior in the 15 quarters of this study, with a particular spell of arrearage behavior lasting only 3.3 quarters on average. This composition appears to also be driven by noncustodial parent earning and the high burden of child support placed on those earning \$1,400 monthly or less. As earnings decrease spells of increasing debt begin to predominate in frequency, duration, and cost. Reversals of debt trend appear largely explained by the relative burden of child support obligation, and do not, on average, appear to be caused by interventions or personal events. With a low burden a noncustodial parent is more able to stop a spell of increasing arrears, and a large debt is less likely to build up. With a high burden a noncustodial parent may not be able to stop a spell of increasing arrears, or may not be able to maintain a spell of decreasing arrears. Adequate intervention to prevent the dynamics of large arrearage growth for particular noncustodial parents may require a view of their historical arrearage pattern relative to the burden of their child support obligation. Every noncustodial parent's earnings and child support obligation should probably be viewed in relation to the information presented in Figure 3.9 (Chapter 3, page 10).

Information in Chapter 3 also allows us to begin constructing a system to classify debt collectibility. We are able to make a preliminary classification of arrearage debt as mostly/partially collectible or mostly uncollectible, after eliminating, because of incomplete information, those who are out of state. The major part of debt growth, \$374.1 million, for in-state noncustodial parents falls into the uncollectible category for low earning noncustodial parents who have barriers to payment, a high burden, and a history of little or no payment.



While barriers are a reasonable confirmation of low earning power, other low earners with barriers do pay when child support obligation is a low percentage of earning. This is particularly seen in the bottom two entries of Table 3.3.b. Those with debt growth have the same number of barriers as those without debt growth, but are expected to pay 60 percent of gross income as opposed to only 17 percent of gross income. The best first strategy here would be to slow or stop arrearage growth by setting obligation appropriate for earnings. For noncustodial parents with multiple cases this requires a view of the total child support responsibility. Possibly some of accumulated debt could be written off. Finally a detailed consideration of the actual payment barriers may suggest ways to help the noncustodial parent become more financially capable.

With high earning noncustodial parents aggressive collection techniques may prove quite successful. These are typically noncustodial parents who have reasonable income, are expected to pay a rather small fraction of their income towards child support, and in fact have a history of meeting most payments.

The biggest problem lies with the noncustodial parents in the low earning category who do not have barriers, who make some payments, but build up large arrears. We estimate \$225.6 million could have been at least partially collectible from this group. Low income, but no barriers, suggests the possibility of hidden income. Here the strategy could be to do a more extensive search for possible earning barriers, and if no barriers can be found, to pursue all possible avenues to uncover income and assets.

In preliminary work related to another project we found that it was possible to rank low earning noncustodial parents who do not pay in order of similarity to low earning noncustodial parents who do pay. The development of this approach could be very valuable in selecting non-payers for scrutiny. The method could also be continuously improved with garnered experience.

The above classifications and strategies can be used in conjunction with the neural network prediction model presented in Chapter 4. Those predicted to have decreased arrears would probably not require attention, and those predicted to be missing should probably be ignored since that outcome cannot be reliably predicted.

But those predicted to have increased arrearage in the future should be a focus of attention. For example, with the 95Q3 cohort the model predicted that 50,331 noncustodial parents would have increased arrearage in 96Q2. Of these 24,031 were classified with uncollectible debt and 13,499 were classified with collectible debt (out-of-state were eliminated). Strategies suggested in Chapter 3 or other appropriate strategies could be applied to the noncustodial parents in the different classifications.

For noncustodial parents predicted to have no change in debt most will be paying regularly and not be a problem. But no debt change can also arise because no order is in place, or because the noncustodial parent only owes arrears. When only arrearage debt is owed but no payment is predicted the debt can be classified by Chapter 3 procedures with implementation of appropriate strategies.

By linking the noncustodial parents in the arrearage study to their associated custodial parents who were part of a study of work and welfare outcomes, we are able to show that how child support obligation is set relative to noncustodial parent earnings has ramifications beyond arrearage growth. Noncustodial parents with a low burden of child support are more likely to have custodial parents receiving regular payment, which, in turn, is more likely to lead to increased custodial parent employment and decreased welfare use. But when child support obligation is set too high relative to earnings arrearage will accrue, and custodial family outcomes can be expected to be less favorable.

This study was placed in a historical time frame before implementation of PRWORA because we wanted a relatively stable period without major changes in regulations. We have, however, recently accumulated similar data for another project, with monthly records for the period from January 1998 through November 2002. Our preliminary work shows virtually identical results to some of the findings reported in Chapter 3. Specifically, the “Zero Contour” produced using the new data is essentially the same as that shown in Figures 3.5 and 3.6 (page 7), the Actual MOA of Figures 3.7 and 3.8 (pages 8,9) appears to be the same, the MTW ratio related to Earnings of Figure 3.10 (page 12) is almost identical, and Arrearage Change related to MTW of Figure 3.11 (page 13) is virtually identical and again shows no group with decreasing arrears above 20 percent MTW.

With the more recent monthly data we are also able to show that noncustodial parents with a low child support burden are linked to custodial parents with more favorable work and welfare outcomes.

We expect that the neural network prediction model of Chapter 4, which was based on quarterly data, could be improved using the monthly data now available. But the neural network prediction tool presented in this report was able to make very good predictions for a new group of noncustodial parents placed in the fourth calendar quarter of 1998.

Thus we do not feel that this study suffers from its historical placing. The findings appear to be equally valid in the more current time frame.



## **Appendix A1: Data Sources and Methods**

The data used in this project is derived from five sources: child support enforcement (CSE) records from DCS data file extracts, CSE records from DCS case file extracts, eligibility records for use of public assistance from the Office of Financial Management (OFM), earnings records for noncustodial and custodial parents from the Employment Security Department (ESD), and records of public program and service use by noncustodial and custodial parents within the Department of Social and Health Services (DSHS) from the Needs Assessment Database for State Fiscal Year 1994 (SFY94 NADB).

### **Longitudinal Analysis**

Data on monthly use of public assistance from October, 1993 through December, 1998 was obtained for the noncustodial parent cohort and for associated custodial parents. We have direct computer access to these records.

Data on quarterly earnings from fourth quarter 1993 (93Q4) through second quarter 1997 (97Q2) were obtained for the noncustodial parent cohort through a special request to ESD. From other work related to welfare use we have access to quarterly earnings records from 1993 forward for anyone with a welfare history.

We completed data share agreements with five DSHS Divisions and obtained NADB cross-match data on the specific program use for 159 programs within those five Divisions for individuals in the noncustodial parent cohort and associated custodial parents. We also have the total number of DSHS programs used by individuals, out of a listing of 296 separate programs in the NADB. Because of timing issues we were able to obtain NADB data for most, but not all, individuals in this study. To reduce the number of variables under consideration we aggregated the NADB information on specific programs by three different procedures. First by DSHS Division, which reduced the number of variables to five. Second within Division by similarity of function as determined by discussions with Division staff, which reduced the number of variables to 30. And third across Division by effects on outcomes determined by logistic analysis, which reduced the number of variables to 48. In some cases these groupings encompassed only one specific program.

From DCS data files we extracted quarterly information from 93Q4 to 97Q2 for developing the prediction models, and extracted additional quarterly information from 97Q3 to 00Q4 for testing applications of the prediction models.

When noncustodial parents had multiple child support cases, the arrears debt and Monthly Order Amounts (MOA) on separate cases were added. For multiple

cases the **Type0** indicator was set to 1 if all cases had case type 0 (unspecified), the **Sbr0** indicator was set to 1 if all cases had case subro 0 (not subrogated debt), the **Payind** indicator was set to 1 if all cases had case payind 1 (automated payment), and the **Iscp** indicator was set to 1 when any case had the CP not in Washington.

Initial work with input variables for predictive power eliminated the 10 variables derived from DCS data listed in Table A1.1. The final input variable test procedure with 25 input variables eliminated the 15 variables listed in Table A1.2. The test procedure is discussed in Appendix A3.

**Table A1.1: DCS Variables with No Predictive Power**

<b>Variable</b>	<b>Definition</b>	<b>Values</b>
<b>NCPage</b>	NCP age	0 – 94
<b>Cpgen</b>	CP gender	0 – 1
<b>CPage</b>	CP age	0 – 93
<b>CaseAge</b>	Case age	0 – 12
<b>Tchld</b>	Total # children active on case	0 – 18
<b>Withhold</b>	Indicates legally collectible case	0 – 1
<b>MOA</b>	Monthly Order Amount	\$0 - \$XXXX
<b>SubWa</b>	NCP location – zip code region in Washington	81 - 99
<b>Wa</b>	NCP zip code state location – in state indicator	0 – 1

**Table A1.2: Variables Eliminated\* in Model Development**

<b>Variable</b>	<b>Definition</b>	<b>Values</b>
<b>Sbr1</b>	Subro case AFDC or TANF	0 - 1
<b>Sbrm</b>	Misc. subro case type	0 - 1
<b>tq</b>	# quarters with earning in base period	0 - 8
<b>Type1</b>	Case type AFDC or TANF	0 - 1
<b>Type2</b>	Case type non-AFDC, non-TANF	0 - 1
<b>Typem</b>	Misc. case type	0 - 1
<b>CaseCnt</b>	# cases linked to NCP in final base quarter	1 - 12
<b>CP</b>	# CP cases linked to NCP in final base quarter	0 - 12
<b>NCP</b>	# NCP cases linked to NCP in final base quarter	0 - 11
<b>Patcnt</b>	# children on case with paternity issues	0 - 7
<b>Isncp</b>	NCP not in WA in final base quarter	0 - 1
<b>NCPengl</b>	NCP limited English	0 - 1
<b>NCPgen</b>	NCP is female	0 - 1
<b>CPelig</b>	# months CP on public assistance in base period	0 - 24
<b>Cpengl</b>	CP limited English	0 - 1

*\* no predictive power, or no enhancement of predictive power when added to variables listed in Table 4.1*

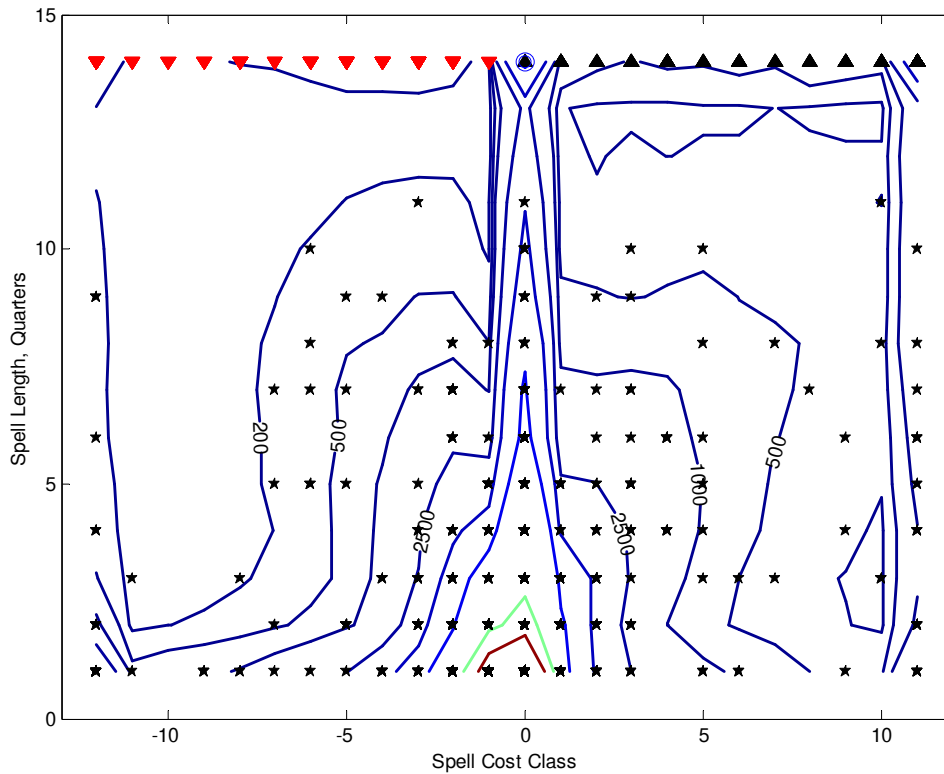
### **Sampling for Case Assessment**

Figure 2.2 was the basis for setting up sampling frames for the case level analysis. To sample the extremes of behavior throughout the 15 quarter period, three sample frames used only spell lengths of 14 quarters. Since an individual with a spell length of 14 quarters can have only one spell in our data, the individuals and associated spells are unique. There are 28,255 individuals with spell length 14 quarters. Of these 13,993 had continually increasing arrearage, 3,084 had continually decreasing arrearage, and 11,015 had no change in arrearage. From each of these three groups a random sample of 200 was drawn by assigning each NCP a randomly generated number, ordering NCPs by this number, and selecting the first 200.

The fourth sample frame for case level study was selected for more typical behavior through the 15 quarter period by requiring individuals to have at least four separate spells of arrearage behavior, including spells of increasing and/or decreasing arrearage. This provided 133,702 NCPs with “intermittent” arrearage behavior from which a random sample of 200 was drawn by the method described above.

Figure A1.1 shows the locations of the randomly drawn samples superimposed on the distribution contour diagram of Figure 2.2.

**Figure A1.1: Spell Length-Spell Cost Location of Case-Level Random Samples\***



*\* continually increasing arrearage sample represented by black apex up triangles; continually decreasing arrearage sample represented by red apex down triangles; no arrearage change sample represented by blue circle at 0 Cost Class and 14 quarters spell length; intermittent sample represented by black star*

Table A1.3 compares the characteristics of the sampling frame populations and also compares the characteristics of the random samples. Note that while the populations differ markedly in some of the characteristics the characteristics of the random sample are generally very close to those of the sampled population. We therefore have confidence that the samples are representative of the populations.

**Table A1.3: Characteristics of Sampled Populations and Random Samples**

	INCREASING		DECREASING		INTERMITTANT		SAME	
	Popul.	Sample	Popul.	Sample	Popul.	Sample	Popul.	Sample
# NCPs	13,993	200	3,084	200	133,702	200	11,015	200
T95Q3	\$20,858	\$21,440	\$9,188	\$8,528	\$5,197	\$5,039	\$1,308	\$1,114
Arrears Change	\$14,436	\$15,131	-\$6,501	-\$5,955	\$871	\$102	\$0	\$0
MOA	\$328	\$347	\$130	\$138	\$213	\$227	\$218	\$189
Monthly earning	\$103	\$123	\$1,102	\$1,088	\$852	\$917	\$1,253	\$1,139
avg MTW	20.33	26.65	0.78	0.73	4.9E+12	0.63	2.94	0.46
median MTW	2.73	1.95	0.06	0.03	0.18	0.18	0.12	0.12
# barriers	1.44	1.28	0.53	0.49	0.83	0.81	0.52	0.61
# cases	1.75	1.74	1.30	1.24	1.27	1.27	1.07	1.06
# cp cases	0.14	0.10	0.05	0.03	0.11	0.10	0.08	0.07
# ncp cases	1.61	1.66	1.35	1.29	1.01	1.01	1.06	1.04
CP Welfare, Mos	15.06	15.09	3.87	2.95	7.63	7.73	4.53	4.68
NCP Welfare, Mos	1.70	1.21	0.12	0.22	1.15	1.16	0.99	0.87
Female	11.8%	11.0%	3.7%	5.5%	11.1%	11.5%	11.5%	11.5%
NCP not in Wa	24.4%	22.0%	19.6%	18.5%	18.4%	17.0%	18.4%	20.5%
CP not in WA	4.8%	6.0%	13.5%	14.5%	7.4%	11.0%	4.4%	5.0%
Payind	98.5%	99.0%	99.3%	99.5%	90.0%	88.0%	76.2%	76.0%
# Qtrs in data	15.00	15.00	15.00	15.00	13.18	13.14	15.00	15.00
subro=0	60.6%	62.5%	38.5%	46.5%	60.3%	60.5%	68.6%	67.0%
subro=1	39.0%	37.5%	60.9%	52.5%	38.8%	39.0%	30.3%	32.0%
durZ	0.00	0.00	0.00	0.00	1.60	1.51	7.00	7.00
durN	0.00	0.00	7.00	7.00	1.87	1.93	0.00	0.00
durP	7.00	7.00	0.00	0.00	2.30	2.31	0.00	0.00
case type=0	6.2%	6.0%	28.7%	26.5%	15.8%	12.0%	18.5%	20.0%
case type=1	44.7%	43.0%	11.1%	8.5%	27.8%	26.5%	16.6%	18.0%

*T95Q3, Payind, durZ, durN, and durP are defined in Table 4.1; subro=0 is the same as Sbr0, and case type=0 is the same as Type0, in Table 4.1; Arrears Change, MTW, and # barriers are defined in Chapter 3; subro=1 is an AFDC case with subrogated debt; case type=1 is an AFDC case. Other data elements should be self-explanatory.*

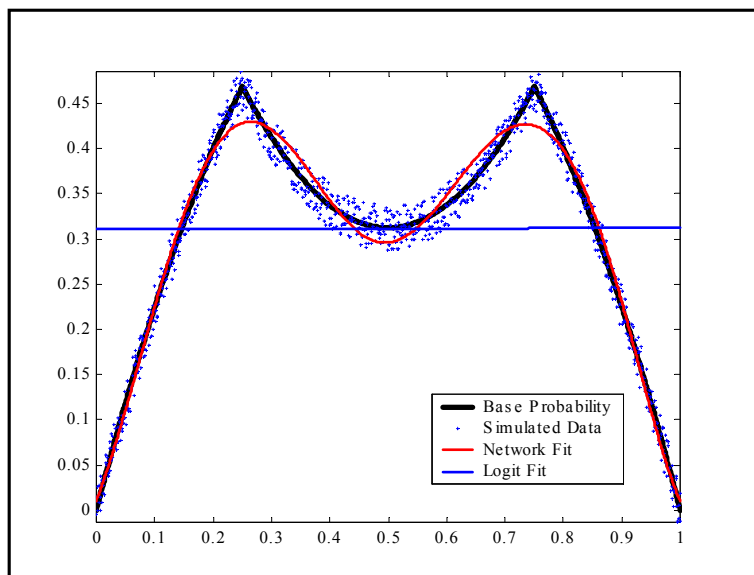




## Appendix A2: Introduction to Neural Network Models

General discussions of neural network simulation can be found in many references (for example, *Ref 1 - 5*), and only a limited overview of the neural network concept will be described here. We use a neural network in what is called 'supervised prediction.' That is, the network response is adjusted to fit known outcomes. This process is similar to standard procedures such as logistic regression, but neural network systems can be much more complex and can act as universal approximators. As detailed in Appendix A3 our final neural network model allows a 127 percent increase in the number of true predictions for arrearage behavior compared to a simple logistic model. For a visual example, simulated data is shown in Figure A2.1. The best that a simple logistic model can do to fit this data is the horizontal line through the average probability of Y, while the neural network fit approximates the features of this data nearly exactly.

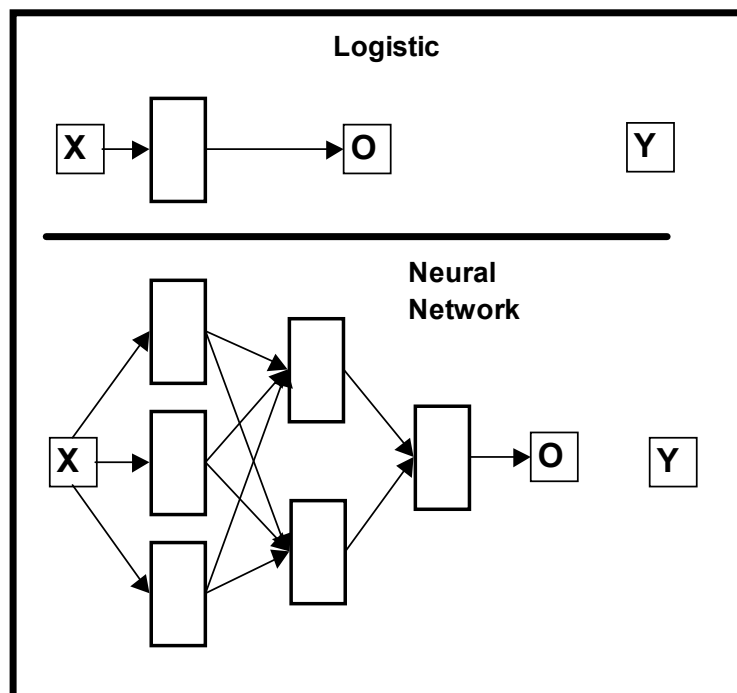
**Figure A2.1: Simulated Complex Data Demonstrating Neural Network Capabilities**



Continuing with this example to help describe neural network terminology, there is one input which contains a single variable (vector) X, and one target which contains a single vector Y. The network internal parameters are adjusted (the network is trained) so that predicted values (outputs) correspond closely to known outcomes (target values). This process is exactly the same as a standard procedure like logistic regression, and in fact a logistic regression can be considered as a simple neural network.

Figure A2.2 compares what is termed network architecture for a simple logistic regression and the network used to fit the sample data in Figure A2.1. In Figure A2.2 each unlabeled inner block, called a neuron, performs operations on inputs and contains an adjustable bias parameter (same as intercept). Connecting arrows, except for connections to the output, contain adjustable weights (same as coefficients). The weighted inputs to a neuron are summed (though there are other possibilities we always use summation). Thus the simple logistic regression has only two adjustable parameters, while the more complex neural network has seventeen adjustable parameters. The network allows outputs from one set of neurons to become inputs to another set of neurons, and outputs are allowed to recombine to approximate target values. This enables a neural network simulation to mimic non-linear and/or non-additive systems.

**Figure A2.2: Network Architecture:  
Two Networks Used on Simulated Data**



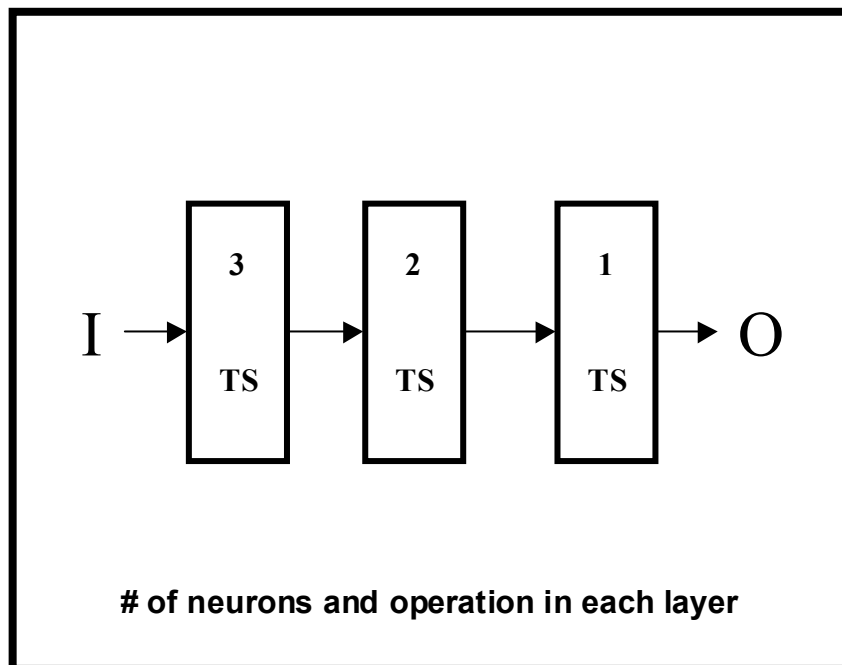
This also demonstrates why the weight and bias parameters of a network have very little meaning. In this simple example with seventeen network parameters, we could set a particular parameter at nearly any value and the other sixteen would compensate to achieve a good fit to the data. Thus the range of variability of the weights and biases can be very large.

The vertical series of neurons in the bottom panel of Figure A2.2 are generally called layers, so this diagram defines the architecture of a three layer network

with three neurons in the first layer, two neurons in the second layer, and one neuron in the third layer (the output layer in this case). The number of neurons in an output layer is equal to the number of vectors in the target associated with that output. In both the Logistic and Neural Network panels in Figure A2.2, training occurs so that  $O$  approximates  $Y$ . We could mathematically represent the Logistic panel in Figure A2.2 as  $Y \sim \hat{O}(X)$  and the Neural Network panel as  $Y \sim \hat{O}_3(\hat{O}_2(\hat{O}_1(X)))$ , where  $\hat{O}_3$ ,  $\hat{O}_2$ , and  $\hat{O}_1$  are the operations performed respectively in the third, second, and first layers. The output of the first layer is  $\hat{O}_1(X)$ , and the output of the second layer is  $\hat{O}_2(\hat{O}_1(X))$ , while the network output is  $\hat{O}_3(\hat{O}_2(\hat{O}_1(X)))$ . It would be possible to write out a detailed mathematical expression for the network output as a function of the network input.

Reflecting the mathematical representation given above, Figure A2.3 shows a simpler way of denoting the network architecture in the bottom panel of Figure A2.2. We will be using the style of Figure A2.3 from this point forward. Each inner block represents a layer with the notation specifying the number of neurons in the layer and the type of neuron operation performed. The single arrows represent all possible forward connections to the indicated layer.

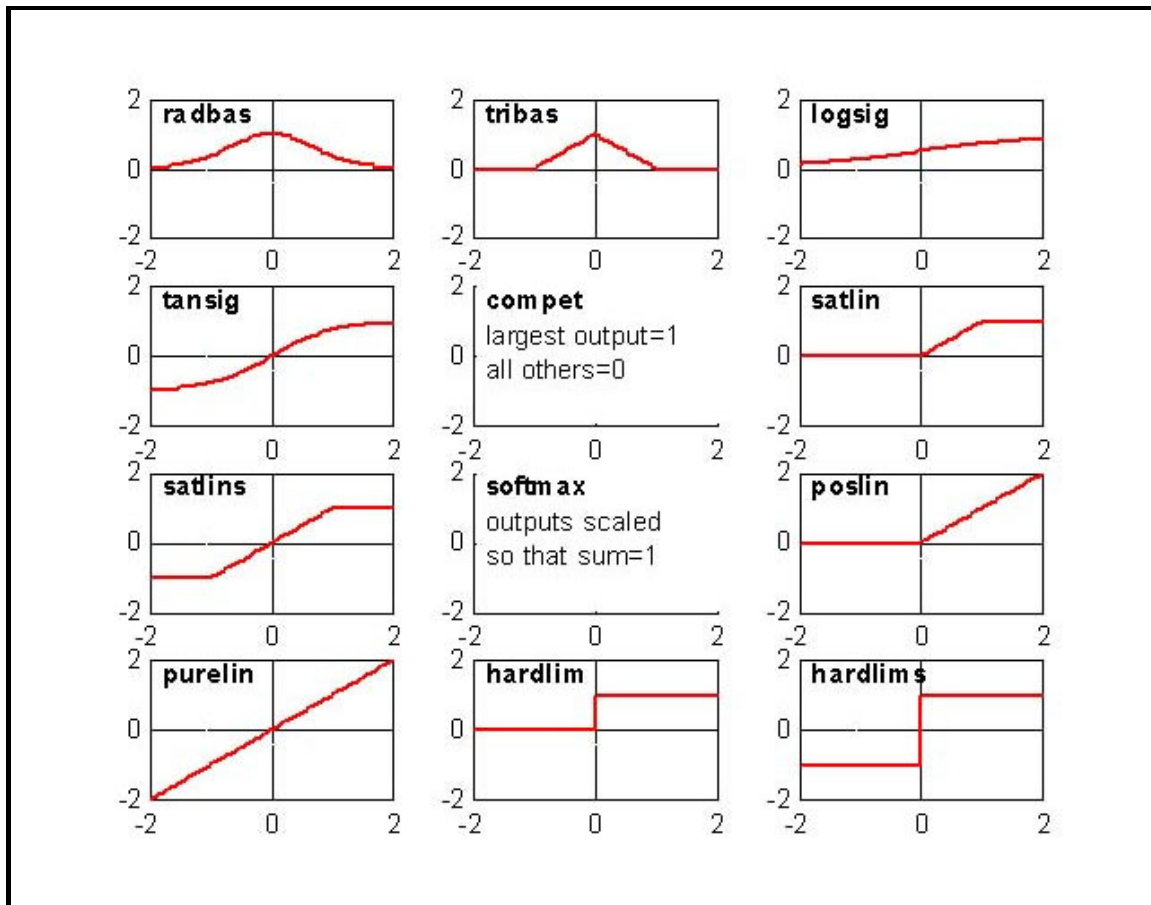
**Figure A2.3: Simplified Network Notation**  
*Same Architecture as bottom of Fig. A2.2*



The neuron operations (called transfer functions) available are shown in Figure A2.4. The x-axis in each sub-chart is the accumulated input value and the y-

axis is the corresponding output value. The **logsig** transform in the upper right corner is the same as a logistic regression (used in the top panel of Figure A2.2). In Figure A2.3 TS represents the **tansig** transform shown on the left of Figure A2.4.

**Figure A2.4: Neural Network Transfer Functions**



## **Appendix A2 References**

1) <http://www.emsl.pnl.gov:2080/proj/neuron/neural/>  
links to nn intros, demos, and many nn reports

2) [http://www.statsoft.com/stat\\_nn.html](http://www.statsoft.com/stat_nn.html)  
Statistica Commercial Software nn site

3) [http://www.dacs.dtic.mil/techs/neural/neural\\_ToC.html](http://www.dacs.dtic.mil/techs/neural/neural_ToC.html)  
This report is intended to help the reader understand what Artificial Neural Networks are, how to use them, and where they are currently being used.

4) <http://www.shef.ac.uk/psychology/gurney/notes/>  
Neural Nets by Kevin Gurney

5) <ftp://ftp.sas.com/pub/neural/FAQ.html>  
SAS Commercial Software FAQ site



## Appendix A3: Development of Neural Network Predictive Model

The noncustodial parent (NCP) cohort is selected as all identifiable noncustodial parents (N=241,731) in DCS records in third quarter of calendar year 1995 (95Q3). In building a prediction model we use the previous seven quarters and 95Q3 as the 'observation' period, and the following seven quarters as the 'outcome' or 'evaluation' period. The general approach is to use data from the observation period to predict arrearage behavior in the outcome period. We worked with a four category outcome model: based on the arrearage debt in 95Q3, in the outcome period debt can increase (**Up**), decrease (**Down**), remain the same (**Same**), or the NCP could be missing (**Miss**) in the outcome quarter so that arrearage change could not be determined.

We use a random sample of 5,000 NCPs (~2 percent of the cohort, we use the same sample throughout, unless otherwise noted) to develop a neural network simulation. Using a smaller sample size gave poorer network performance, but using a larger sample did not improve performance. The input to the network are data elements from the observation period, and the network is trained using the known outcomes for the 5,000 NCP sample. The trained network is then tested by making predictions for each individual in the entire cohort. Predictions are evaluated by comparing with known outcomes.

### Selecting Input Variables

In evaluating predictions, simply measuring the number of correct predictions is not adequate because it is easier to correctly predict outcomes which are more likely. For selection of input vectors we used an information theory approach. Information content is estimated by the number of binary (yes/no) questions needed to obtain the result. In our arrearage prediction model, considering four possible outcomes, we would need two binary questions for each individual. In the language of information theory one binary question is one 'bit' of information; doing a complete prediction of outcomes would require about  $2 \times 241,731 = 483,462$  bits of information. But this approach overestimates information when outcomes are not equally likely. The more general relationship below (*Equation 1*) allows an accurate calculation of information content.

$$I = - N \sum P_i \log_2 P_i \quad (\text{Equation 1})$$

where I is the information content, N is the number of individuals, and  $P_i$  is the probability of the ith outcome. Estimating  $P_i$  as the fractional frequency of



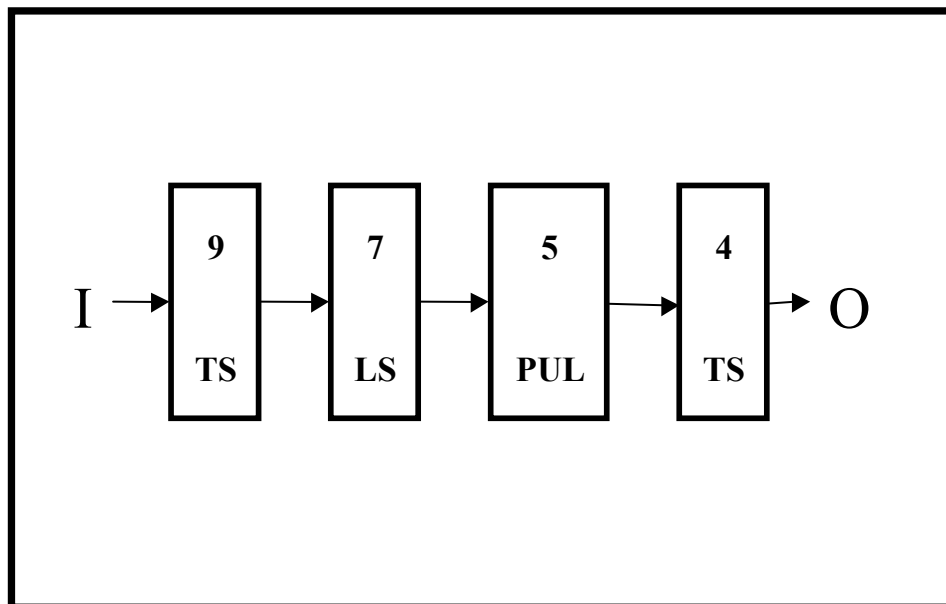
occurrence of each outcome,  $f_i$ , and substituting the number of individuals with each outcome,  $N_i = N * f_i$ , we have:

$$I = - \sum N_i \log_2 f_i \quad (\text{Equation 2})$$

Information content is maximized when all outcomes are equally likely and is then equal to the information content estimated by the number of binary questions. We can consider  $-\log_2 f_i$  as the bits of information per individual for each outcome. This quantitatively adjusts for the difficulty of correct prediction. We can thus determine exactly the minimum amount of information required to completely predict arrearage outcomes using several possible outcome models. Using actual outcomes in the seventh quarter after 95Q3, a model with two outcome categories would require 234,700 bits of information, four categories would require 456,800 bits, and six categories would require 610,600 bits.

Beginning with a set of 25 variables derived from DCS, ESD, and OFM data we used the preliminary neural network shown in Figure A3.1 to determine which

**Figure A3.1: Preliminary Neural Network for Testing Inputs**  
*TS = tansig, LS = logsig, PUL = purelin; see Figs. A2.3 & A2.4*



*see Appendix A2 for explanation of notation*

vectors contained predictive information. We tested input vector information by comparing the prediction information content to that for the same vector sub-

mitted in scrambled order. Since a prediction may be sensitive to the values and distribution of an input this allows for a completely fair comparison. First testing vectors singly and then in various groupings we selected the ten input vectors shown in Table 4.1 which consistently showed predictive power.

All numerical input vectors, such as **durZ** and **Elig**, were doubly transformed in order to improve network training. First a logarithmic transformation was effected by adding 1 to each value (since the vectors contain zero values) and then taking the natural logarithm. The second transformation was a normalization where the mean value of the singly transformed variable was subtracted from each transformed value, with the result divided by the standard deviation of the singly transformed variable. The resulting numerical vectors submitted to the neural network thus have a mean of zero and a standard deviation of one. Indicator vectors were not transformed.

We also have data on cross-program use for a sub-set of the 95Q3 cohort. Using this sub-cohort of 195,401 NCPs with a different random sample of 5,000 NCPs we found eight input vectors (shown in Table 4.7) derived from cross-program data which appeared to contain predictive information when combined with the ten vectors in Table 4.1. However, we did not include these vectors in our predictive models because cross-program administrative data is difficult to obtain.

After development of predictive models 32 additional variables derived from detailed case studies were tested in combination with the ten vectors listed in Table 4.1. Since this could only be tested with NCPs selected for case study the sample is too small to say with certainty that predictability is improved, but the results suggest that the three variables defined in Table A3.1 possibly would improve predictions.

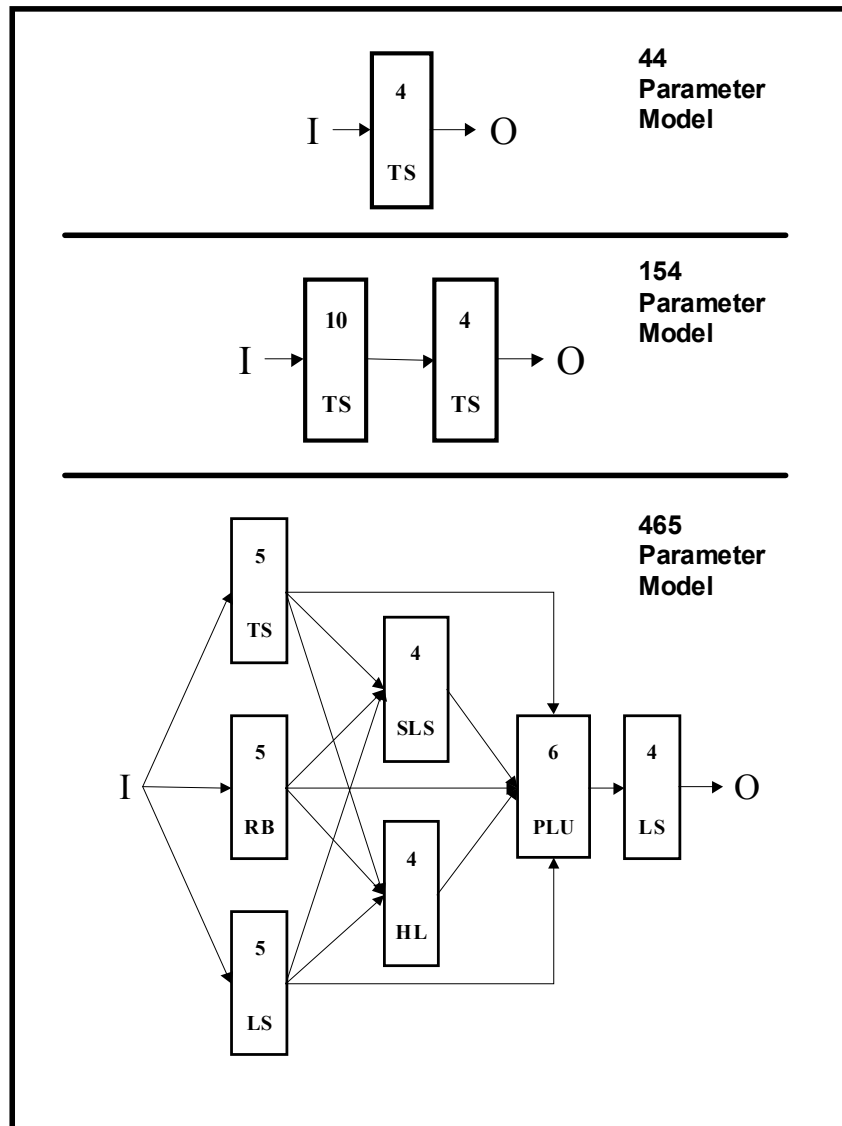
**Table A3.1: Case Variables with Possible Predictive Power**

Variable	Definition	Type
<b>BasA</b>	Basis on 1 <sup>st</sup> original order undeterminable	Indicator
<b>Bas2D</b>	Basis on 2 <sup>nd</sup> original order blank – no 2 <sup>nd</sup> order	Indicator
<b>Lowerarrspmt</b>	Negotiated lower monthly payments on arrears	Indicator

### Selecting Network Architecture

In our child support arrearage prediction work we have one input with ten vectors and one target with four vectors. Many different network architectures were examined, but we limit the discussion to three illustrative examples. See Figure A3.2 for the architectures of these models.

**Figure A3.2: Three Neural Network Prediction Models**



*see Appendix A2 for explanation of notation*

The simplest model possible (in the top panel of Figure A3.2) would have one layer with four neurons, and would be similar to a multinomial logistic regression. There are ten input weight parameters and one bias parameter associated with each neuron for a total of 44 parameters. Inserting an additional layer of ten neurons between the output layer and the input increases the complexity of the second model (in the middle panel of Figure A3.2) to 154 parameters. Finally the bottom panel of Figure A3.2 shows the model we actually use in making predictions, one with 465 parameters. The additional complexity is justified because it allows us to make reliable predictions for significantly more NCPs.

Table A3.2 shows results comparing predictions made with the three models. All of these predictions are the average of ten separate runs with newly initiated nets and a standard training. This was necessary since network results can be sensitive to initial parameter values.

**Table A3.2: Testing the Models Shown in Figure A3.2  
95Q3 Cohort, Q7 Prediction Results**

		N		
		241,731		
Params		44	154	465
<b>MISS</b>	fp	18.2%	56.4%	56.2%
	fa	5.3%	6.8%	15.7%
	ntp	429	468	1,675
	np	2,359	830	2,980
	na	8,162	6,858	10,700
<b>UP</b>	fp	66.9%	71.3%	70.1%
	fa	81.3%	84.5%	76.7%
	ntp	20,627	26,819	28,713
	np	30,814	37,638	40,944
	na	25,374	31,739	37,443
<b>DOWN</b>	fp	69.8%	70.7%	67.1%
	fa	69.1%	68.7%	70.6%
	ntp	13,546	16,496	19,577
	np	19,420	23,337	29,185
	na	19,605	24,003	27,711
<b>SAME</b>	fp	26.2%	66.3%	63.9%
	fa	30.5%	77.2%	79.1%
	ntp	1,021	3,730	9,134
	np	3,889	5,626	14,294
	na	3,341	4,831	11,548
<b>TOTS</b>	ntp	35,622	47,514	59,099
	np	56,482	67,431	87,403
	fp	63.1%	70.5%	67.6%
	fc	23.4%	27.9%	36.2%

see Table 4.3 footnote for definitions

Because the procedure selects those individuals that have more reliable predictions (see next section) the overall accuracy of prediction is not a good measure of prediction quality. In developing our final models we used the total number of true predictions as the comparative measure. As model complexity increases in Table A3.2 the total number of true predictions (**ntp** in the Totals block) increases from 35,622 to 59,099, a 66 percent increase. In the steps (which will

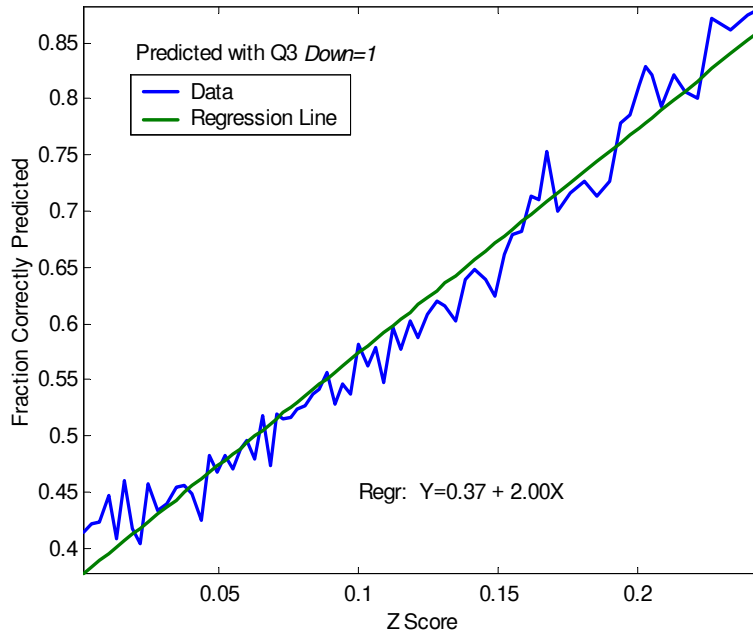
not be detailed) between the 154 parameter model and the 465 parameter model complexity was allowed to increase when the more complex model consistently enabled correct predictions for a larger number of individuals. Additional optimization of the final model allowed 80,718 true predictions for Q7 (presented in Table 4.3), an increase of 127 percent over the simple logistic model.

### **Selection of More Reliable Predictions**

The neural network model output gives values between 0 and 1 for each output category. In preliminary work we simply converted the largest value to a 1 (assuming this to be the most likely outcome) and the rest to 0s. But we have discovered additional information in the network model output. It is reasonable to suppose that when the largest value is much larger than the other values the prediction is more certain – in the limit of all values equal, no prediction would be possible.

When network outputs are scaled (using the **softmax** transfer function from Figure A2.4) so that they add to 1 for each individual, the outputs become similar to probabilities, and are comparable from individual to individual. We then take the difference, for each individual, between the largest output value and the next largest value, and for convenience we call this the **Z Score**. Next ranking predictions by **Z Score**, and taking groups of 1000 individuals we look at the fraction correctly predicted as **Z Score** increases. Figure A3.3 shows an example with the results for the prediction of the **Down** outcome. The regression line is nearly the same for all outcomes: Accuracy = 0.4 + 2\*(Z Score).

**Figure A3.3: Accuracy of Prediction is Related to Z Score**  
***Regression Line is Approximately the Same for All Outcomes***



These results make it very clear that we can have more confidence in predictions which have a larger **Z Score**. For some individuals we can make fairly certain predictions, but for others predictions may not be very meaningful. Our final model system allows predictions to be made only when they are likely to be correct by imposing the condition that **Z Score** have a value of at least 0.1. This cut-off is a good compromise between accuracy of prediction and number of allowed predictions. The cut-off is easy to change if more accurate predictions are desired, or if we wish to make predictions for more individuals. Table A3.3 shows how, using our final models, accuracy of predictions and number of predictions change with increasing **Z Score** cut-off. For example, as the **Z Score** cut-off is raised from 0 to 0.2, Q7 accuracy of prediction increases from 55.7 percent to 78.4 percent, but the number of predictions drop from 100 percent of the cohort to 10.9 percent of the cohort.

**Table A3.3: Predictions with Increasing Z Score Cut-Off  
95Q3 Cohort Prediction Results**

N		241,731					
Q, Z		Q3, 0	Q7, 0	Q3, 0.1	Q7, 0.1	Q3, 0.2	Q7, 0.2
<b>MISS</b>	fp	46.6%	43.1%	53.9%	63.4%	67.2%	73.6%
	fa	11.5%	29.4%	7.8%	20.5%	5.1%	21.5%
	ntp	2,061	12,302	725	3,241	156	752
	np	4,421	28,511	1,344	5,114	232	1,022
	na	17,996	41,851	9,340	15,791	3,047	3,497
<b>UP</b>	fp	64.1%	54.2%	73.5%	66.0%	82.2%	77.3%
	fa	63.8%	63.7%	75.7%	78.3%	74.2%	67.9%
	ntp	49,634	45,178	36,992	28,860	12,924	3,555
	np	77,396	83,423	50,331	43,698	15,727	4,601
	na	77,743	70,949	48,873	36,876	17,418	5,234
<b>DOWN</b>	fp	56.2%	52.6%	70.0%	64.7%	80.3%	76.9%
	fa	55.1%	48.3%	57.3%	54.6%	53.7%	75.3%
	ntp	26,848	20,761	13,703	10,548	2,469	1,931
	np	47,770	39,444	19,574	16,300	3,074	2,512
	na	48,768	42,981	23,923	19,304	4,600	2,566
<b>SAME</b>	fp	67.1%	62.5%	75.8%	72.6%	82.7%	79.2%
	fa	77.4%	65.7%	88.2%	83.5%	96.7%	95.7%
	ntp	75,249	56,501	58,679	38,069	34,500	14,493
	np	112,144	90,353	77,416	52,466	41,710	18,303
	na	97,224	85,950	66,529	45,607	35,678	15,141
<b>TOTS</b>	ntp	153,792	134,742	110,099	80,718	50,049	20,731
	np	241,731	241,731	148,665	117,578	60,743	26,438
	fp	63.6%	55.7%	74.1%	68.7%	82.4%	78.4%
	fc	100.0%	100.0%	61.5%	48.6%	25.1%	10.9%

see Table 4.3 footnote for definitions

### Optimum Definition of Outcomes

In preliminary work we used an outcome definition where **Same** meant that the difference in arrears between the prediction quarter and the evaluation quarter was exactly \$0.00. We felt that this might be too restrictive, and so examined the results of allowing **Same** to be defined as  $\pm D$ , where D varied from \$0.00 to \$1500. Best results - in terms of accuracy of predictions, number of predictions, and generally good predictions for the four separate outcome categories - were obtained with  $D=\$300$  for Q3 outcomes and  $D=\$700$  for Q7 outcomes. Specifically, when the difference in arrears is greater than or equal to \$300 the Q3 outcome is classified as **Up**; and when the difference in arrears is less than or

equal to -\$300 the Q3 outcome is classified as **Down**. Likewise for Q7 with the \$700 limit.

### **Optimum Network Training**

Standard training for a network is 100 iterations. This means using the training data set (the random sample of 5000 individuals and their known outcomes) in 100 cycles where network outputs are compared with targets, and based on this comparison network parameters are adjusted to provide a hopefully better approximation. For simple problems the standard training is usually adequate, but we found that arrearage prediction results improved when additional training occurred. The Q3 prediction model is the result of 450 training iterations, and the Q7 prediction model is the result of 500 training iterations. Additional training either deteriorated results or did not improve results.





## Appendix A4: Development of Decision Tree Model

A decision tree can be used as a hierarchical classification system, usually implemented by an ordered series of queries. As with the neural network model it is developed by supervised prediction - we need input information on which to classify and we need known outcomes to measure prediction quality. Once developed the classification system can be applied where inputs are known but outcomes are unknown.

Each query, or decision point, in a decision tree is designed to obtain the best separation on the outcome of interest. There are two issues here - what complexity of separation are we going to consider, and how do we define “best.”

### Complexity of Decision Points and Decision Trees

For dichotomous variables complexity is not an issue because there can be only two results from a query of such a variable. But if we query the input variable **Elig** which has 25 levels a decision point could yield up to 25 branches. And the input variables **T95Q3** and **Earn** are continuous. This could become very complicated, but since we are developing decision tree predictions for simplicity, we restrict all decision points to be binary - to have only two branches. This then is like asking a yes/no question, for example: “is **Elig** greater than 4 months?” will have only two possible answers. Thus to limit the enormous number of possible decision trees all numerical variables are converted to dichotomous indicators. We have experimented with expanding the numerical variable conversion to four levels, which produced a richer variety of decision trees but did not appear to improve predictability.

For variables with a limited number of levels - **durZ**, **durN**, **durP**, and **Elig** - all possible dichotomous indicators were created and tested to determine the best indicator at the first decision point for each of these variables. For each continuous variable up to twenty candidate dichotomous variables are created, and the one which gives the best results at the first decision point is used as part of the input data set. We also experimented with re-dichotomization of variables at each decision point, but this did not improve results.

To maintain simplicity we only pursued decision trees with three levels - this means that each individual will be queried at three decision points, and at the end of the decision process individuals will have been sorted into eight groups.

We experimented with taking each arrearage outcome separately, or treating them together as we do in the neural network prediction model. A separate decision tree for each outcome gave better predictability. We limit ourselves to models predicting the outcomes **Up**, **Down**, and **Same**; it does not appear possible to accurately predict the outcome **Miss**.

## Quality of Decision Points

We use three techniques in selecting the best variable to query at each decision point, and in determining threshold values in converting multi-level and continuous variables to dichotomous. The first technique is based on information theory (see Appendix A3 for a brief discussion of information theory), and looks for the biggest adjusted information gain after splitting the group. For example, a query which allowed a perfect separation of the input group (say into a sub-group in which all individuals had the **Up** outcome and a sub-group in which none of the individuals had the **Up** outcome) would have an information gain of 100 percent since no further information would be necessary for classification. The second technique is maximum likelihood, which in this instance is related to an unadjusted information gain. The third technique constructs a contingency table for each variable and chooses the variable producing the largest chi square.

Figure A4.1 gives examples of a useless decision point where no separation has been achieved and no information gained, and a perfect decision point where maximal separation has been achieved and there is maximal information gain.

**Figure A4.1: Example of Decision Point Quality**

